

APPLIED METAMODELLING

A FOUNDATION FOR LANGUAGE DRIVEN DEVELOPMENT

SECOND EDITION



Tony Clark, Paul Sammut, James Willans¹



¹Based on the first edition by Tony Clark, Andy Evans, Paul Sammut, James Willans

CONTENTS

Preface	ix
Preface (First Edition)	ix
1 Language-Driven Development	1
1.1 Challenges Facing Developers Today	1
1.1.1 Coping with Complexity	2
1.1.2 The Challenge of Diversity	3
1.1.3 The Only Constant is Change	4
1.2 Language-Driven Development - Providing the Solution	5
1.2.1 Languages are the Future	5
1.2.2 Rich Organised Abstraction	6
1.2.3 Appropriate Abstraction Through Multiple Languages	6
1.2.4 Integration - Weaving the Rich Tapestry of Languages	8
1.2.5 Evolvability - The Key to Managing Change	9
1.2.6 Language-Driven Development - The Complete Solution	9
1.3 From Model-Driven to Language-Driven Development	10
1.3.1 The Unified Modelling Language	10
1.3.2 MDA	12
1.4 Language Engineering and Metamodelling	13
1.5 Conclusion	14
2 Metamodelling	15
2.1 Introduction	15
2.2 Features of Languages	15
2.2.1 Concrete Syntax	16
2.2.2 Abstract Syntax	16
2.2.3 Semantics	17

2.2.4	Mappings	18
2.2.5	Extensibility	18
2.3	Modelling Languages vs. Programming Languages	18
2.4	What is a Metamodel?	19
2.5	Why Metamodel?	20
2.5.1	Metamodels and Tools	20
2.6	Where do you find Metamodels?	21
2.7	Metamodelling Languages	21
2.8	Metamodel Architectures	22
2.8.1	Traditional Metamodel Architecture	22
2.8.2	Golden Braid Metamodel Architecture	23
2.9	The Metamodelling Process	24
2.10	Five levels of Metamodelling	25
2.11	Conclusion	26
3	A Metamodelling Facility	27
3.1	Introduction	27
3.2	Requirements of a Metamodelling Facility	27
3.2.1	XMF	28
3.3	XMF Features	29
3.3.1	Core OO Modelling Concepts	29
3.3.2	Imports	30
3.3.3	Constraints	31
3.3.4	Queries	31
3.3.5	Actions and XOCL	32
3.3.6	Instantiation	34
3.3.7	Concrete Syntax	34
3.3.8	Mappings	36
3.4	XMF Architecture	39
3.4.1	XCore Metamodel	40
3.5	Relationship to Existing Metamodelling Languages	41
3.6	Conclusion	42
4	Abstract Syntax	45
4.1	Introduction	45
4.2	Modelling Abstract Syntax	45
4.3	The Process	46
4.3.1	Concept Identification	46
4.3.2	Use Cases	48
4.3.3	Concept Modelling	48
4.3.4	Well-formedness Rules	49
4.3.5	Operations and Queries	49
4.3.6	Validation and Testing	49

4.4	Case Study	49
4.4.1	Identification of Concepts	51
4.4.2	The Model	52
4.4.3	Metamodel Reuse	53
4.4.4	Well-formedness Rules	54
4.4.5	Operations	55
4.4.6	Validating the StateMachine Metamodel	56
4.5	Conclusion	57
5	Concrete syntax	59
5.1	Introduction	59
5.2	Textual Syntax	60
5.2.1	Parsing text using EBNF	60
5.2.2	Parsing text using XBNF	61
5.2.3	Building Abstract Syntax	63
5.3	Diagrammatic Syntax	67
5.3.1	Parsing Diagrams	67
5.3.2	Building Abstract Syntax	68
5.3.3	Building Diagrams from Abstract Syntax	71
5.4	Conclusion	72
6	Semantics	75
6.1	Introduction	75
6.2	What is Semantics?	75
6.3	Why Semantics?	76
6.4	Semantics and Metamodels	77
6.5	Approaches	78
6.6	Translational Semantics	78
6.6.1	Approaches	79
6.6.2	Example	80
6.7	Operational Semantics	83
6.7.1	Example	83
6.8	Extensional Semantics	85
6.8.1	Example	86
6.9	Denotational Semantics	86
6.9.1	Example	87
6.10	Process	89
6.11	Conclusion	90
7	Executable Metamodelling	91
7.1	Introduction	91
7.2	Why Executable Metamodelling?	91
7.2.1	Executability and XMF	92

7.2.2	Executable Metamodelling and Programming	92
7.3	Adding Executability	93
7.3.1	XOCL Extensions	94
7.4	Examples	95
7.4.1	Example 1: Model Merge	95
7.4.2	Example 2: Find and Replace	96
7.4.3	Example 3: Walker	97
7.4.4	Example 4: Meta-Patterns	100
7.5	Conclusion	101
8	Mappings	103
8.1	Introduction	103
8.2	Applications Of Mappings	104
8.2.1	Vertical Mappings	104
8.2.2	Horizontal Mappings	105
8.2.3	Variant Dimensions	105
8.3	Types of Mappings	106
8.3.1	Unidirectional Mappings	106
8.3.2	Synchronised Mappings	106
8.4	Requirements of a Mapping Language	107
8.5	XMap	108
8.6	XMap Syntax	109
8.7	XMap Examples	111
8.7.1	StateMachines to Java	112
8.7.2	Mapping to XML	116
8.8	Mapping Specifications	120
8.9	Mapping Issues	121
8.9.1	Merging	121
8.9.2	Traceability	122
8.10	XSync	122
8.10.1	Examples	123
8.11	Conclusion	125
9	Reuse	127
9.1	Introduction	127
9.2	Extension Based Approaches	127
9.2.1	Specialisation	128
9.2.2	Stereotyping, Tags and Profiles	129
9.2.3	Package specialisation and Meta-Packages	130
9.3	Translation Based Approaches	133
9.3.1	Example	134
9.4	Family of Languages	134
9.5	The XCore Framework	134

9.6	Conclusion	136
10	Case Study 1: An Aspect-Oriented Language	139
10.1	Introduction	139
10.2	AOL	139
10.3	Language Definition Strategy	140
10.4	Abstract Syntax	140
10.4.1	Identification of Concepts	140
10.4.2	Abstract Syntax Model	141
10.5	Semantics	141
10.6	Concrete Syntax	143
10.7	Conclusion	144
11	Case Study 2: A Telecoms Language	145
11.1	Introduction	145
11.2	The Case Study: OSS/J Inventory	145
11.3	Abstract Syntax Model	147
11.3.1	Well-formedness Rules	148
11.4	Concrete Syntax	149
11.5	Semantics	149
11.6	Instantiation	150
11.7	Transformations	152
11.8	Tool Mapping	153
11.9	Conclusion	154
12	Case Study 3: A Simple Programming Language	157
12.1	Introduction	157
12.2	XAction	157
12.2.1	XAction Values	158
12.2.2	XAction Expressions	160
12.2.3	XAction Statements	162
12.3	An Evaluator for XAction	165
12.3.1	Evaluating Expressions	165
12.3.2	Evaluating Statements	167
12.4	A Translator for XAction with Run-Time Types	169
12.4.1	Translating Expressions	169
12.4.2	Translating Statements	171
12.5	A Translator for XAction without Run-Time Types	173
12.5.1	Translating Expressions	174
12.5.2	Translating Statements	175
12.6	Compiling XAction	178
12.6.1	Compiling Expressions	178
12.6.2	Compiling Statements	180

12.7	Abstract Syntax to Concrete Syntax	182
12.8	Conclusion	185
13	Case Study 4: Interactive TV	187
13.1	Introduction	187
13.2	Interactive Application Architecture	188
13.3	A DSL for Interactive Applications	190
13.4	Implementation	194
13.4.1	Syntax	194
13.4.2	Semantics	202
13.4.3	Handling Events	209
13.5	Simulation	210
13.6	XML Representation for Applications	212
13.7	Conclusion	214
14	Case Study 5: Graphs	217
14.1	Introduction	217
14.2	A Model of Graphs	217
14.3	Graph Applications	219

PREFACE

Since publishing the first edition in 2004 we were pleasantly surprised by how much momentum *Applied Metamodelling* created. The fundamental tenors of the book have been cited in a vast number of papers and book and key ideas have been influential in a number of technology initiatives including the Eclipse Modeling Project [EMP08].

A recurring response that we commonly receive is a frustration that although the book gives readers the knowledge to apply metamodelling, they cannot easily do this using the XMF technology which was used to construct the examples in the book. This is about to change with the release of XMF as an open source technology in the first quarter of 2008².

Much has happened since 2004 but the fundamental problem of complexity in software and systems remains. This second version of the book makes a number of corrections to the original text and includes a number of new chapters including two additional case studies which demonstrate the application and benefits of metamodelling.

²See <http://www.ceteva.com> for more details

PREFACE

(First Edition)

Modern day system developers have some serious problems to contend with. The systems they develop are becoming increasingly complex as customers demand richer functionality delivered in ever shorter timescales. They have to manage a huge diversity of implementation technologies, design techniques and development processes: everything from scripting languages to web-services to the latest 'silver bullet' design abstraction. To add to that, nothing stays still: today's 'must have' technology rapidly becomes tomorrow's legacy problem that must be managed along with everything else.

How can these problems be dealt with? In this book we propose that there is a common foundation to their resolution: *languages*. Languages are the primary way in which system developers communicate, design and implement systems. Languages provide abstractions that can encapsulate complexity, embrace the diversity of technologies and design abstractions, and unite modern and legacy systems.

Language-Driven Development

Understanding how we can manage languages to best fit the needs of developers is the key to improving system development practises. We call this *Language-Driven Development*. The right languages enable developers to be significantly more productive than using traditional development practices. Rather than dealing with a plethora of low level technologies, developers can use powerful language abstractions and development environments that support their development processes. They can create mod-

els that are rich enough to permit analysis and simulation of system properties before completely generating the code for the system. They can manipulate their models and programs in significantly more sophisticated ways than they can code. Moreover, provided the language definitions are flexible, they can adapt their languages to meet their development needs with relative ease.

Metamodelling

In order to realise Language-Driven Development, we need the ability to rapidly design and integrate semantically rich languages in a unified way. *Metamodelling* is the way to achieve this. A metamodel is a model of a language that captures its essential properties and features. These include the language concepts it supports, its textual and/or graphical syntax and its semantics (what the models and programs written in the language mean and how they behave). Metamodels unify languages because the same metamodelling language is used in each case. Significant advantage can be made of this unification to construct powerful and flexible design environments for languages. These enable the rapid assembly of Language-Driven Development tools that give developers the power they need to design their systems faster, cheaper and more flexibly.

Purpose of this Book

The aim of this book is to advance the state of the art in metamodelling to the point at which it can realise the Language-Driven Development vision. Traditionally, metamodelling has focused on the design of data centric models of language concepts. In this book, we go way beyond that, showing how they can capture all aspects of languages, including concrete syntax, abstract syntax and semantics in a sound and pragmatic way.

This book also aims to fill a large gap in the metamodelling literature, providing a technically rich book on an a subject that is mentioned often, but for which there is little concrete material available. Metamodels are increasingly being used across wider application domains, and it is the intention that this book will provide good advice to metamodellers irrespective of the languages and tools they are using.

Scope of this Book

The scope of this book is deliberately not restricted to software systems. Many other types of domains, from systems engineering to business, manufacturing and even physical engineering, can benefit from the ideas presented here.

Intended Audience

This book should be useful to anyone who has an interest in the design of languages, language and model-driven development, and metamodelling. Our intention is that the book has an industrial focus, and we have tried hard to ensure that it is relevant to real practitioners. In particular, everything in this book has been implemented, therefore ensuring that it is has been tried and tested.

Relationship to Other Approaches

We do not claim that the ideas presented in this book are new. Approaches to rapidly designing languages in flexible ways have been around since the early days of LISP, ObjVLisp and Smalltalk. Meta-case tools have been widely touted as a means of designing tailored tools and languages. Efforts by the Object Management Group (OMG) to standardise facilities for capturing language meta-data are already influencing the way vendors build tools. More recently, work on domain specific languages has highlighted the benefits of rapidly designing languages targeted at specific application domains.

In this book we have combined many of these approaches on top of existing standards to facilitate the definition of languages in a general and complete way. An important emphasis has been on raising the level of abstraction at which complex aspects of language design such as the definition of concrete syntax and semantics are expressed. Thus we *model* languages, but in sufficient detail that these models can be turned into semantically rich development environments and tools. This capability has not been achieved in such a complete way before.

Organisation of this Book

This book is organised into three parts. The first and shortest part gives an overview of challenges facing the system development industry and proposes Language-Driven Development as a way forward to addressing those challenges.

The middle part provides a detailed treatment of metamodelling. It contains the following chapters:

Metamodelling : introduces the key features of languages and describes what meta-models are and how they can capture those features.

A Metamodelling Facility : presents an overview of an executable metamodelling facility that provides a number of powerful languages for capturing the syntax and semantics of languages.

Abstract Syntax : describes how metamodels can be used to define the concepts that are provided by the language.

Concrete Syntax : describes how the textual and diagrammatical syntaxes of language can be modelled.

Semantics : introduces semantics and the motivation for having them in language definitions. The chapter goes on to describe four different approach to describing semantics.

Executable Metamodelling : discusses how the addition of a small number of action primitives to a metamodelling language turn it into a powerful metaprogramming environment for Language-Driven Development.

Mappings : motivates and presents two languages for transforming and relating meta-models.

Reuse : this chapter describes a number of different approaches to reusing existing language metamodels.

The final part provides a number of indepth case studies each describing a specific example of metamodelling. These examples range from the design of a small general purpose language to a domain specific language for modelling interactive television based applications. The case studies are a significant resource for demonstrating meta-modelling best practice.

Acknowledgements

We are grateful to the following people for giving us feedback on early versions of the book and the technology it is based on: Manooch Azmoodeh, Steve Crook-Dawkings, Tom Dalton, John Davies, Kevin Dockerill, Desmond D'Souza, Karl Frank, Nektarios Georgal, Robert France, Sheila Gupta, Martin Hargreaves, Girish Maskeri, Stephen Mellor, Joaquin Miller, Alan Moore, Alphonse Orosun, John Rowlands, Bran Selic, Laurence Tratt, Andrew Watson, Stephen Whymark.

CHAPTER 1

LANGUAGE-DRIVEN DEVELOPMENT

This chapter provides an introduction to Language-Driven Development. It outlines current problems facing software and systems developers today, and explains how an integrated architecture of semantically rich, evolvable languages can provide huge productivity benefits to industry.

Language-driven development is fundamentally based on the ability to rapidly design new languages and tools in a unified and interoperable manner. We argue that existing technologies do not provide this capability, but a language engineering approach based on *metamodelling* can. The detailed study of metamodelling and how it can realise the Language-Driven Development vision will form the focus for the remainder of this book.

1.1 Challenges Facing Developers Today

When discussing software and systems engineering, it is only a matter of time before the topic of managing complexity arises. The desire to manage complexity was the driving force behind the emergence of the aforementioned disciplines, and despite many valiant attempts to master it, the problem is still with us today. However, we believe that the nature of today's systems are quite different to those developed when those disciplines emerged, and in turn the developers of today's systems face different challenges to those in previous decades. In particular, it is no longer sufficient to manage complexity alone. Instead, we believe that most of today's development challenges boil down to a combination of three important factors: complexity, diversity and change.

The remainder of this section describes each of these challenges in more detail.

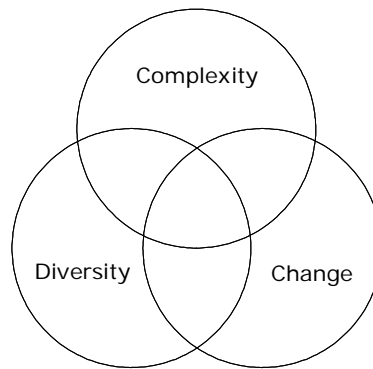

Figure 1.1: Challenges Facing Developers Today

1.1.1 Coping with Complexity

As hardware costs have plummeted and development and manufacture techniques have improved, the demands for more sophisticated systems have been relentless. Of course, the more sophisticated the requirements of a system are, the larger and more complex the deployed system is likely to be. Increased system complexity typically brings with it the following problems:

- longer development times;
- more complex assembly due to number of components and number of people involved;
- increased cost and time for testing;
- increased maintenance costs.

Overall, this results in an increased time to market for any system, and increased development and maintenance costs in order for there to be any confidence that the quality of the system is not compromised.

For software systems, as well as the problems outlined above which relate to the fundamental increase in lines of code, there is an additional qualitative difference to the systems being developed today compared to those of decades past. Modern systems are increasingly distributed in nature, as demonstrated by the ubiquity of enterprise applications. This adds another dimension to software complexity, and brings added challenges of communication and security to those listed above.

Since the challenge of managing complexity is the main topic of many software and systems engineering books (such as [Som95, Boo94, Jac92], it will not be discussed in further detail here. Potential solutions to the complexity challenge are described in section 1.2.2.

1.1.2 The Challenge of Diversity

The challenge of diversity reflects how developers have to manage in a non-homogenous environment. Life would be much easier if there was only one programming language and one deployment platform, but of course this is not the case, and for very good reasons. Diversity is not really a single challenge, but a category of challenges, outlined below. Section 1.2.4 describes how diversity as a whole can be managed.

Diverse Domains

The requirements of large systems often relate to a variety of domains that need to be reconciled by different stakeholders. These requirements may range far and wide, including functional, safety, security and performance considerations. Each domain often has its own specialist approach for dealing with appropriate requirements, but their specialist nature inevitably precludes them from being applied in other domains.

Diverse Customer Requirements

The 'one size fits all' approach to software and systems is increasingly inappropriate in today's market. Vendors who offer products that can be tailored to the specific needs of a customer have a strong commercial advantage, but developing products that are truly customisable such that they can meet the demands of a broad customer base is a far from trivial matter. Despite the fact that two products being offered to different customers may share significant functionality, large rewrites and redesign are often required because the functional components of a system are too tightly coupled to allow large scale reuse. In addition, many systems are designed at too lower a level of abstraction to yield optimum flexibility.

Diverse Implementation Technologies

Systems are often deployed across a number of different implementation technologies which need to be integrated, or need to be deployed for a number of separate implementation technologies. These implementation technologies each have their own requirements and languages. However, the separation between the core functionality and the requirements of the deployment platform is rarely kept clean during the development of the system. It has been recognised that in order to support redeployment and integration (or indeed other customisation such as that described above), systems need to be designed at a high level of abstraction; thus software and system modelling has become popular, but these models are rarely complete (this is described more fully in section 1.2.2). Software models in particular seldom get beyond the specification of their behaviour, such that code cannot be completely generated. Even when code is generated, full testing and validation is usually required, which consumes a significant chunk of development effort.

Diverse Tools and Artefact Types

During the development of a system, a large number of artefacts are created, including requirements specifications, design documentation, design and analysis models, analysis and simulation data and of course the code (for software systems). Unfortunately, these artefacts are often prevented from being truly valuable assets because:

- they are often created by different incompatible tools or using different languages, some of which may no longer be supported, such that the artefacts become un-maintainable;
- the forms of artefacts are incompatible, and many are written in informal languages, such that there is no clear way to integrate the information they contain;
- artefacts such as design models are rarely kept in step with changes to the implementation artefacts such as code, because there is no automatic way to do so, vastly reducing their value as assets;
- the artefacts that are kept up to date, such as code, are often tightly coupled to the integration technology, reducing their value as reusable assets;
- many artefacts only exist on paper rather than electronic form, so any maintenance or integration tasks has to be manually.

This may be fine for one-off systems, but systems are rarely built from scratch - they are often based on existing systems, and as such would ideally reuse as much as possible from the baseline system.

1.1.3 The Only Constant is Change

Nearly all systems evolve over time. Typical reasons for this are:

- change in customers requirements or market trends;
- change in implementation technologies or deployment platforms;
- support for additional functionality and features;
- availability of more effective implementation solutions;
- bug fixes.

One can see a parallel between the challenges of change and diversity described above. The distinction is that diversity is meant to reflect the potential variations of a system at one point in time, whereas change is meant to reflect the variation of a single system over time.

Once again the problem of managing change is intertwined with the problem of complexity. Traditionally systems have been developed at too lower level of abstraction, and code is not always the ideal starting point for managing change.

Ultimately, managing change is costly and timely - system maintenance is well known to be an expensive activity, and that is only part of the bigger challenge of managing change. Problems are compounded when a tool, platform or other technology involved in the design, development and deployment of the system becomes obsolete. It can either become even more expensive or in some cases impossible to continue to maintain a system. It is clear then that any technique or technology that can aid in managing change will have a direct beneficial effect on the bottom line and shorter lead times for delivery. This is the topic of section 1.2.5.

1.2 Language-Driven Development - Providing the Solution

1.2.1 Languages are the Future

One of the distinguishing features of being human is our use of language. Languages are fundamental to the way we communicate with others and understand the meaning of the world around us.

Languages are also an essential part of systems development (albeit in a more formalised form than natural languages). Developers use a surprisingly varied collection of languages. This includes high-level modelling languages that abstract away from implementation specific details, to languages that are based on specific implementation technologies. Many of these are general-purpose languages, which provide abstractions that are applicable across a wide variety of domains. In other situations, they will be domain specific languages that provide a highly specialised set of domain concepts.

In addition to using languages to design and implement systems, languages typically support many different capabilities that are an essential part of the development process. These include:

- *Execution*: allows the model or program to be tested, run and deployed;
- *Analysis*: provides information of the properties of models and programs;
- *Testing*: support for both generating test cases and validating them must be provided;
- *Visualisation*: many languages have a graphical syntax, and support must be provided for this via the user interface to the language;
- *Parsing*: if a language has a textual syntax, a means must be provided for reading in expressions written in the language;

- *Translation*: languages don't exist in isolation. They are typically connected together whether it is done informally or automatically through code generation or compilation;
- *Integration*: it is often useful to be able to integrate features from one model or program into another, e.g. through the use of configuration management.

Languages are the true universal abstractions, and hold the key to managing the challenges described in section 1.1. This section describes how particular facets of languages can help to solve the individual problems described above, and how they can combine to form the holistic solution of Language-Driven Development.

1.2.2 Rich Organised Abstraction

Abstraction has long been used as a means to allow humans to cope with complexity. Abstraction concerns distilling the essential characteristics of something relative to a particular perspective of the viewer. The two key ideas here are that some non-essential details are ignored, and that a particular context needs to be defined in order for the abstraction to make sense. Often abstraction involves the 'chunking' and organisation of information in a particular problem domain in order to allow the viewer to better comprehend the problem, by separating concerns. It is this information chunking that is the fundamental means for overcoming the limited human capacity for complexity, and languages are the means for capturing abstractions.

Organised abstraction is the key tool that formed the basis of the disciplines of software and systems engineering from the outset right through to recent trends in model-driven development. However, there has been a backlash against modelling and concerns that high-level abstraction doesn't work for complex large scale systems. This has come from a recognition that current model-driven technologies have failed to deliver the increased productivity that was promised. However, we argue that abstraction is still a crucial tool - it's just that the wrong abstractions have been used in the past.

This is partly because there has been a tendency for inappropriate languages to be used for capturing abstractions - this is covered in section 1.2.3. More significantly, modelling languages often use 'high-level' as an excuse to suggest that their abstractions need not be unambiguous, complete, meaningful or executable. This simply does not work. Abstraction is a means of *hiding* detail appropriately from various stakeholders, but that detail must still be there. Also, if such abstractions have no meaning or its meaning is ambiguous, then the potential applications on that abstraction are severely limited - validation, verification, translation, integration, execution and simulation rely heavily on semantically precise abstractions.

1.2.3 Appropriate Abstraction Through Multiple Languages

Section 1.1.2 highlighted how diversity lies at the heart of modern system development. Going a step further, we suggest that the challenge really boils down to a diversity of

languages:

- specialists require languages to address the particular facets of the problem that lie within their domain - often within each specialist domain there are numerous languages, with new languages being developed all the time;
- there are countless implementation languages - some differences are due to the continuing trend of increasing abstraction, some are due to the fact that different paradigms or individual languages are better suited to a particular problem-solution pair than others, and some are simply down to competitive commercial interests;
- the languages and syntax that capture the artefacts created during the development lifecycle.

We propose that rather than trying to subdue this diversity by forcing everyone to talk (or model) using the same language, we should embrace it and allow everyone to use whatever language best suits their needs. In many cases, this may be a general-purpose modelling or programming language, as these will be widely supported by tools and techniques, but in some cases more specialised languages may be more appropriate. An example of this might be an inventory-based system, where developers consistently have to express their models in terms of inventory type concepts such as resources, services and products. By allowing engineers and domain experts to express themselves in the languages that they are both most comfortable with and that will give them the most expressive power, productivity can increase with corresponding gains for industry.

The argument against this is that by having a single standard language, there is only one language for developers to learn, so everyone can communicate more easily, and interoperability between tools will be much simpler. Whilst this is undoubtedly true, in order to make a modelling language that suits the needs of everybody (not just software engineers), it will suffer from the following problems:

- it will necessarily be a very large, bloated language;
- there are often contradictory needs of a language from different domains that cannot be reconciled in a single language;
- any gain made in widening the applicability of a language to different domains will be at the expense of the richness of the language that makes it so suitable for a particular domain.

The compromises that can happen due to conflicting requirements of a language can be seen clearly in programming languages. These languages sit uncomfortably between the realms of the computer hardware and the human developer. As humans, we want readable, maintainable and reusable code, but ideally we also want to produce a set of

efficient machine instructions to keep the computer happy. The trend of increasing abstraction that has resulted in Object-Oriented Programming has resulted in more usable languages, but at the expense of performance. Thus a single language is not enough.

1.2.4 Integration - Weaving the Rich Tapestry of Languages

In section 1.2.3, we suggested that large productivity gains could be achieved by opening up the full spectrum of languages. However, this vision will not work with isolated language islands - we need to find a way for all the models and other artefacts for a system written in these disparate languages to make sense as a meaningful whole. In order for that to happen, the languages themselves must be integrated.

Language integration between two languages means that some or all of the language constructs of each language are in some way mapped to corresponding constructs of the other language. Some common applications of language integration are outlined below:

Transformation

The most publicised application of language integration is that of transformation, where an artefact in one language is transformed into an artefact of another. This type of activity is of prime importance in MDA (see section 1.3.2), as reflected by dominance of the concept of transforming Platform Independent Models (PIMs) to Platform Specific Models (PSMs). Language-Driven Development goes a step further by enabling high-level models to be transformed directly into fully compiled executable systems, so long as the appropriate languages that capture such views of a system are integrated appropriately. Transformation activities also include reverse engineering, and generation of any secondary artefacts such as documentation or even full test beds for systems.

Artefact Integration

If a system is comprised of a number of subsystems from different domains, and these different system aspects are described in different languages, then by integrating the languages, those aspects can themselves be weaved together to form a unified view of the system. This is typically used to integrate language artefacts that are at a similar level of abstraction.

Equivalence Verification

Sometimes it is important to check whether an artefact written in one language is equivalent to one written in another. For example, it may be important to check whether an implemented system conforms to a precise system specification written in a high-level language. Again if the two languages are integrated appropriately, then this will be possible.

Synchronisation

Language integration can also enable language artefacts to be synchronised. For example, whilst in some cases it might be appropriate to generate code for a system from a high-level model as a one-shot activity, in many cases it is desirable to keep the model and code in step. Similarly, if you have a diagramming language that allows graphical representation of a modelling languages, it is important to keep the graphical entities in step with any changes to the model.

1.2.5 Evolvability - The Key to Managing Change

Languages evolve in the same way as systems, and the best way to protect systems against change and obsolescence is to protect the languages that describe them. They should be flexible and extensible to cope with changing requirements, and when a new version of a language is developed, mappings (as described in section 1.2.4 should be provided to provide full traceability between versions. In this way, an artefact written in an earlier version should be able to be transformed into the new version. With some legacy systems, the language is no longer well-supported. In these cases, the language should be described and integrated within the Language-Driven Development framework, such that corresponding artefacts can be transformed into artefacts in a new more current and appropriate language. In summary, good language design (see Chapter 9) together with language integration enables both languages and systems to evolve in a controlled fashion.

1.2.6 Language-Driven Development - The Complete Solution

This section has described how languages can provide the overall solution to the challenges described in section 1.1 - more specifically an integrated framework of semantically rich, flexible and evolvable languages appropriate to their needs. This Language-Driven Development framework will:

- allow the construction of agile abstractions that are resistant to change;
- enable those abstractions to be transformed into, integrated with, validated against or synchronised with abstractions written in other languages;
- support powerful applications (editors, analysis and simulation tools, the aforementioned transformers and integrators) to be written and applied on those abstractions.

The right languages enable developers to be significantly more productive than using traditional development technologies because engineers and domain experts can speak in the languages they understand. Rather than dealing with low level coding issues, developers can use powerful language abstractions and development environments that

support their development processes. They can create models that are rich enough to permit analysis and simulation of system properties before completely generating the code for the system, and are more reusable and agile. They can manipulate their models and programs in significantly more sophisticated ways than they can code. Moreover, provided the language definitions are flexible, they can adapt their languages to meet their development needs with relative ease.

Language-Driven Development is the next generation development paradigm which can provide a step gain in productivity through the recognition that languages, rather than objects or models, are the abstractions needed for today's development environment.

1.3 From Model-Driven to Language-Driven Development

Much of what has been described in this chapter has a lot in common with model-driven development approaches such as the OMG's Model Driven Architecture (MDA). However, there are two prime motivations for distinguishing Language-Driven Development from model-driven approaches:

- the term *model* suggests a focus on high-level abstractions and *modelling* languages, with other artefacts seen as of lesser value. We feel that languages itself are the truly central abstractions, and that modelling languages form an undoubtedly useful yet partial subset of the spectrum of useful languages in system development. Consequently, all language artefacts, not just models, have a crucial role to play in the process;
- the prominent model-driven approach, MDA, is limited in its scope of application, compared to the full potential of Language-Driven Development (see section 1.3.2).

The remainder of this section examines two key model-driven technologies from the Object Management Group, UML and MDA, and assesses their suitability for the basis of Language-Driven Development.¹

1.3.1 The Unified Modelling Language

The Unified Modelling Language (UML) came out of a desire to consolidate all the notations in the various object-oriented methodologies that had arisen in the eighties and nineties, such as Schlaer-Mellor [SM88] and OMT [RBP⁺91]. UML consists of a number of different notations that allow different views of a software system to be modelled at

¹Two other key technologies underpinning MDA are the Meta-Object Facility (MOF) and the Query/View/Transformations language (QVT). MOF is the metamodelling language for MDA, and QVT is the mappings language for MOF - both are described in section 3.5.

different stages of the development lifecycle. Both static and dynamic aspects of a system can be captured, and facilities are also provided to enable model management and limited extensibility. A textual constraint language (OCL) is included to allow the state space represented by a model to be further constrained in ways that are too complex to be captured by the graphical notations alone.

As highlighted earlier, there are certainly advantages of having a common language such as UML, particularly with regard to communication. In line with this, UML has been well-received and is now the *de facto* software modelling language. However, it has some major shortcomings:

Imprecise semantics

The UML 1.x specification [uml01] falls some way short of providing a precise semantics. Whilst its syntax is mostly well specified, the semantics of those syntactic elements is either missing or provided informally using English. This has led to a situation where, as of version 1.3, no tool could claim to be UML compliant [CEF⁺99]. This in turn has inhibited model interchange between tools, leading back to the situation of vendor lock-in. In addition, as explained earlier, models written in such an informally specified language are open to misinterpretation, a potentially dangerous or expensive problem. Whilst a major revision of UML will be released soon, draft versions of the UML 2.0 standard do not indicate major improvements with regard to semantics.

Limited scope and flexibility

UML has been successfully applied across the software development community, and it is increasingly being applied to non-software domains such as systems engineering[uml02], and specialised software domains such as real time and high integrity systems. The diverse modelling requirements that this widespread use brings makes defining what a unified modelling language should be a considerable problem. Early attempts to enhance UML to support new requirements adopted a 'mud-packing' approach[Kob99], which involved making direct amendments to the monolithic definition of UML itself. This resulted in a language that became increasingly large, unwieldy to use, incomprehensible, and difficult to maintain and test for consistency.

In order to overcome these problems, UML was refactored from a one-size-fits-all modelling language into a family of languages. The foundation of the UML family is a stable core UML metamodel, consisting of minimal modelling concepts that are supported by all family members. Each dialect of UML consists of the UML core metamodel and one or more extensions to the core known as 'profiles'. The profile mechanism is quite straightforward to apply, but is limited as it is based upon constraining existing language constructs rather than modifying or adding new language constructs.

Non-executability

UML is not in itself executable - it was designed to be a declarative language. In other words you cannot run a UML model as defined in the specification, merely define a specification to which any executable program must conform. This is certainly useful, but does not (in the general case) allow executable code to be generated automatically from the model. This was deemed to be a desirable application of models, so an Action Semantics extension was provided. Whilst this was a step in the right direction, like much of UML, the semantics of this extension is weakly defined.

These shortcomings are constantly being addressed by revisions of the language. At the time of writing, UML 2.0 is due to be released in the near future. This addresses some of the problems of imprecise semantics, and improves the profile mechanism of UML 1.4, but it is still limited by the fundamental flaw of trying to have a one-size-fits-all language. UML started out as general purpose object-oriented modelling language, and was good at describing high level object-oriented software models. But as a consequence of its popularity, attempts were made to tailor for more and more highly specialised uses for which it was not originally intended. Developing it as an extensible language was a major step forward, but the core that the profiles are built upon is still an object-oriented core, which does not suit the needs of all languages. We are not proposing that UML should be scrapped, simply that it used where it makes sense to use it - and use other languages where the abstractions provided by UML do not fit.

1.3.2 MDA

The Model Driven Architecture is framework for unifying a number of technologies based around OMG standards such as UML, MOF, CWM and CORBA. It is founded on the metamodelling language MOF, which is used to define other languages such as UML and CWM.

Primarily MDA concerns models and mappings between those models. The most widely recognised application of MDA is the mapping or transformation between Platform Independent Models (PIMs) and Platform Specific Models (PSMs). A key idea is that system models are constructed that realise all the functional requirements, but are completely independent of platform, programming language and other implementation issues (PIMs). Instead of producing code for a system manually, a model that contains all the constructs and details needed for the system to operate on the intended implementation technology (the PSM) is generated from the appropriate PIM using a mapping. Because the core functionality of a system is captured in the PIM, if that system needs to be deployed on to a new platform, a new PSM can be generated simply by changing the PIM to PSM mapping. Thus faster platform migration and platform independence are achieved through the large scale reuse that PIMs provide [mda01].

MDA is an ambitious vision that could change the way software is developed in the

future. However, as with UML, it has some problems:

- whilst the MDA vision is grand, the technology for implementing it is very vaguely specified. So weak in fact that any modelling tool which has some simple code generation facility can (and in most cases does) claim to implement MDA. MDA is more useful as a marketing tool than anything else;
- MDA is too fixed on the notion of *platform*. What constitutes a *platform* is unclear at best - the transition from the most abstract model of a system to the most refined model may include several stages of models, each which could be considered Platform Specific when compared to the previous stage, or Platform Independent when compared to the following stage. In any case, PIM to PSM mappings are just one of a whole spectrum of potential applications of Language-Driven Development;
- MDA is built on a weak inflexible architecture. This will be discussed in the context of metamodelling in section 2.8.

Language-Driven Development is not just about PIM to PSM mappings - it is about being able to capture all aspects of the software and systems development process in a unified way, through the rich tapestry of languages described in section 1.2.

1.4 Language Engineering and Metamodelling

In order for a development process to be truly adaptable, it is not simply a case of enabling it to support a number of pre-defined languages. If a development process limits itself to the application of a fixed set of languages, it will still necessarily limit the range of problems that it can address as well as the potential solutions it can provide. Instead, a development process should incorporate the ability to adopt and construct whatever languages provide the best fit. In other words, on top of the disciplines of Software and System Engineering, there needs to be a new discipline for Language Engineering.

Language engineering is required whenever the integrated language framework does not support the problem-solution pair. For example, if Language-Driven Development is required on a problem domain that has its own specialist language or if a new programming language is developed, then that language must be captured in an appropriate form to support Language-Driven Development technologies. However language engineering involves not just the construction of semantically rich languages for capturing appropriate abstractions (section 1.2.2). It also involves the integration of such languages within the language framework (section 1.2.4) and the evolution of such languages (section 1.2.5). Thus language engineering provides the foundation for all we have described in this chapter.

Language engineering is a more complex activity than software and system engineering needing specialised skills, however only a fraction of Language-Driven Development practitioners will be involved in this activity. For most system developers, it will

be sufficient to know that languages need not be static entities, and that languages can be customised, extended and created as needed. Some of these language engineering tasks they may be able to carry out themselves, and some (particularly the creating of new languages entirely) will have to be carried out by language specialists.

In order to be able to engineer languages, we need a language for capturing, describing and manipulating all aspects of languages in a unified and semantically rich way. This language is called a metamodelling language. Metamodels (models of languages) are the primary means by which language engineering artefacts are expressed, and are therefore the foundation for Language-Driven Development. While we have motivated Language-Driven Development in this chapter, the rest of the book will explore how metamodelling (the process of creating metamodels) can realise the Language-Driven Development vision.

1.5 Conclusion

This chapter has outlined some of that the key challenges facing developers today are complexity, diversity and change. It has proposed that Language-Driven Development can help developers to manage these challenges by utilising the following tools:

- abstraction through rich languages helps to manage complexity;
- integration of multiple appropriate languages help to manage diversity;
- flexible, evolvable languages help manage change.

An outline as to how Language-Driven Development differs from model-driven development was then given, along with an overview of existing model-driven technologies and their limitations. The chapter closed with an introduction to the discipline of Language Engineering, which this book is fundamentally about, and is described in more detail in the following chapter.

Language-Driven Development provides practitioners with an integrated framework of rich evolvable languages appropriate to their needs. Productivity can be increased because engineers and domain experts can speak in the languages they understand, and both the problem space and solution space are opened up to their full extent, and artefacts developed in this way will be more agile, powerful, reusable and integrated. This approach offers a paradigm shift beyond object-oriented programming and modelling that has major implications for industry in terms of cost reduction and productivity.

CHAPTER 2

METAMODELLING

2.1 Introduction

The previous chapter described the benefits of using semantically rich languages to precisely capture, relate and manipulate different aspects of a problem domain. These languages may be general purpose languages, domain specific languages, modelling languages or programming languages. In order to realise these benefits, a way must be found of defining languages in a unified and semantically rich way. In this chapter we begin exploring a means of achieving this using *metamodels*.

This chapter sets out to explain a number of key aspects of metamodelling that lay the foundation for the rest of this book. An important starting point is to understand the features of languages that a metamodel must be capable of describing. A definition of a metamodel is then given, and the type of language necessary to construct metamodels with is explored. This language, a metamodelling language, is just another example of a language. As we will see later in the book, all language metamodels can be described in this language: thus facilitating the unified definition of the languages that underpins Language-Driven Development.

2.2 Features of Languages

Whilst the nature, scope and application of the languages used in systems development is naturally diverse, there are a number of key features they all share. Understanding these features is a first step towards developing a generic approach to modelling languages.

2.2.1 Concrete Syntax

All languages provide a notation that facilitates the presentation and construction of models or programs in the language. This notation is known as its *concrete syntax*. There are two main types of concrete syntax typically used by languages: textual syntax and visual syntax.

A textual syntax enables models or programs to be described in a structured textual form. A textual syntax can take many forms, but typically consists of a mixture of declarations, which declare specific objects and variables to be available, and expressions, which state properties relating to the declared objects and variables. The following Java code illustrates a textual syntax that includes a class with a local attribute declaration and a method with a return expression:

```
public abstract class Thing
{
    private String nameOfThing;
    public String getName ()
        {return nameOfThing;}
}
```

An important advantage of textual syntaxes is their ability to capture complex expressions. However, beyond a certain number of lines, they become difficult to comprehend and manage.

A visual syntax presents a model or program in a diagrammatical form. A visual syntax consists of a number of graphical icons that represent views on an underlying model. A good example of a visual syntax is a class diagram, which provides graphical icons for class models. As shown in Figure 2.1 it is particularly good at presenting an overview of the relationships and concepts in a model:

The main benefit of a visual syntax is its ability to express large amounts of detail in an intuitive and understandable form. Its obvious weakness is that only certain levels of detail can be expressed beyond which it becomes overly complex and incomprehensible.

In practice, utilising a mixture of diagrammatical and textual syntaxes gains the benefits of both forms of representation. Thus, a language will often use visual notations to present a higher level view of the model, whilst textual syntax will be used to capture detailed properties.

2.2.2 Abstract Syntax

The *abstract syntax* of a language describes the vocabulary of concepts provided by the language and how they may be combined to create models. It consists of a definition of the concepts, the relationships that exist between concepts and well-formedness rules

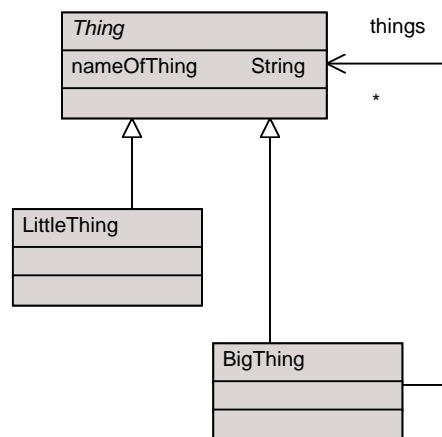

Figure 2.1: Visualising concepts and relationships

that state how the concepts may be legally combined.

Consider a simple state machine language. An abstract syntax model of this language may include concepts such as *State*, *Transition* and *Event*. In addition, there will be relationships between concepts, such as a *Transition* being related to a source and target *State*. Finally, well-formedness rules will be defined that ensure, for example, that no two transitions may be triggered by the same event.

It is important to emphasise that a language's abstract syntax is independent of its concrete syntax and semantics. Abstract syntax deals solely with the form and structure of concepts in a language without any consideration given to their presentation or meaning.

2.2.3 Semantics

An abstract syntax conveys little information about what the concepts in a language actually mean. Therefore, additional information is needed in order to capture the semantics of a language. Defining a semantics for a language is important in order to be clear about what the language represents and means. Otherwise, assumptions may be made about the language that lead to its incorrect use. For instance, although we may have an intuitive understanding of what is meant by a state machine, it is likely that the detailed semantics of the language will be open to misinterpretation if they are not defined precisely. What exactly is a state? What does it mean for transition to occur? What happens if two transitions leave the same state. Which will be chosen? All these questions should be captured by the semantics of the language.

It is critical that semantics should be captured in a way that is precise and useful to the user of the language. An abstract mathematical description has little benefit if it cannot be understood or used. Instead, a semantic definition that provides rich ways of interacting with the language should be the goal of the language designer: An executable

language should have an operational semantics that allows it be run; A language which contains type concepts, such as classes, should permit the creation of objects according to the rules of instantiation, and so on.

2.2.4 Mappings

In the real world, languages do not exist in isolation. They will have a relationships to other languages. This may be via translation (concepts in one language are translated into concepts in another language); semantic equivalence (a language may have concepts whose meaning overlaps with concepts in another language) or abstraction (a language may be related to another language that is at a different level of abstraction). Capturing these relationships is an important part of a language's definition as it serves to place the language in the context of the world around it. Furthermore, mappings exist between the internal components of languages, such as between a concrete and abstract syntax, and are an important part of a language's architecture (see section 9.4).

2.2.5 Extensibility

Languages are not static entities: they change and evolve over time. For instance, new concepts may be added that enable common patterns of model or code to be expressed more succinctly, whilst unused elements of the language will eventually die out. The ability to extend a language in a precise and well-managed way is vital in order to be able to support adaptability. It allows the language to adapt to new application domains and to evolve to meet new requirements. Furthermore, extensibility enables the commonality and differences between languages to be precisely captured.

2.3 Modelling Languages vs. Programming Languages

A strong distinction has traditionally been made between modelling languages and programming languages (a fact reflected by the two distinct modelling and programming communities!). One reason for this is that modelling languages have been traditionally viewed as having an informal and abstract semantics whereas programming languages are significantly more concrete due to their need to be executable.

This is not the case in this book. Here, we view modelling languages and programming languages as being one and the same. Both have a concrete syntax, abstract syntax and semantics. If there is a difference, it is the level of abstraction that the languages are targeted at. For instance, UML tends to focus on specification whilst Java emphasises implementation. However, even this distinction is blurred: Java has been widely extended with declarative features, such as assertions, whilst significant inroads have been made towards developing executable versions of UML.

Another common distinction made between modelling and programming languages is their concrete syntax. Modelling languages tend to provide diagrammatical syntaxes,

whilst programming languages are textual. However, the representational choice of a language should not enforce this distinction. There is nothing to say that a modelling language cannot have a textual syntax or that programming language cannot have a visual syntax: it is purely a matter of representational choice. Indeed there is already a human readable textual form of UML and tools that provide visual front ends to programming languages like Java are commonplace.

If modelling languages and programming languages are essentially the same, why can't the mature techniques used to define programming languages be used to design modelling languages? The answer is that they can - indeed many of the techniques presented here have their foundation in programming language design. However, there is one important element that is missing from many approaches to defining programming languages, and that is unification. It is the ability to define multiple languages that co-exist in a unified meta-architecture that make metamodelling such a powerful technology.

Thus, the techniques that are developed in this book are equally as applicable to programming languages as they are to modelling languages. A critical failing of modelling languages is that they have not, until now, been given the precise, executable definitions that programming languages enjoy.

2.4 What is a Metamodel?

In its broadest sense, a metamodel is a model of a modelling language. The term "meta" means transcending or above, emphasising the fact that a metamodel describes a modelling language at a higher level of abstraction than the modelling language itself.

In order to understand what a metamodel is, it is useful to understand the difference between a metamodel and a model. Whilst a metamodel is also a model (as defined in chapter 1), a metamodel has two main distinguishing characteristics. Firstly, it must capture the essential features and properties of the language that is being modelled. Thus, a metamodel should be capable of describing a language's concrete syntax, abstract syntax and semantics. Note, how we do this is the major topic of the rest of this book!

Secondly, a metamodel must be part of a *metamodel architecture*. Just as we can use metamodels to describe the valid models or programs permitted by a language, a metamodel architecture enables a metamodel to be viewed as a model, which itself is described by another metamodel. This allows all metamodels to be described by a single metamodel. This single metamodel, sometimes known as a meta-metamodel, is the key to metamodelling as it enables all modelling languages to be described in a unified way. How metamodels can be *described* by a meta-metamodel is discussed in more detail in section 2.8.

It is important to be aware that there is a good deal of confusion about what is meant by a metamodel in the literature. Many standards such as UML [uml01], CWM [cwm04] and MOF [mof00] provide 'metamodels' that claim to define the standard, yet they only

focus on the abstract syntax of the languages. They should really be viewed partial metamodels (or even just models) as they do not provide a complete language definition.

2.5 Why Metamodel?

As discussed in chapter 1, system development is fundamentally based on the use of languages to capture and relate different aspects of the problem domain.

The benefit of metamodelling is its ability to describe these languages in a unified way. This means that the languages can be uniformly managed and manipulated thus tackling the problem of language diversity. For instance, mappings can be constructed between any number of languages provided that they are described in the same metamodelling language.

Another benefit is the ability to define semantically rich languages that abstract from implementation specific technologies and focus on the problem domain at hand. Using metamodels, many different abstractions can be defined and combined to create new languages that are specifically tailored for a particular application domain. Productivity is greatly improved as a result.

2.5.1 Metamodels and Tools

The ability to describe all aspects of a language in a metamodel is particularly important to tool developers.

Imagine the benefits of loading a metamodel of a language into a tool that defined all aspects of the language. The tool would immediately understand everything relating to the presentation and storage of models or programs in the language, the users' interaction with and creation of models or programs, and how to perform semantically rich activities, such as execution, analysis and testing. Furthermore, any number of other languages could also be loaded in the same way, enabling the construction of semantically rich development environments. Because all the languages are defined in the same way, interoperability between the tools would be straightforward. This flexibility would not just be restricted to user level languages. Another example might be loading an extension to the meta-metamodel, such as a new kind of mapping language. This language would then be immediately available to capture mappings between different languages.

Allowing all aspects of tools to be modelled in a single, platform independent metamodelling language will have big implications for the software engineering industry. Firstly, the interoperability and flexibility of tools will be drastically increased. This will lead to a marketplace for tool metamodels. Metamodels that provide partial definitions of languages could be easily extended to provide many other capabilities by vendors with expertise in a specific modelling domain.

Secondly, rich metamodels will have a significant benefit to the standards community. As we have argued, there is currently no means of capturing complete language definitions in existing metamodeling languages. As a result, standards that use metamodels to describe the languages they define suffer because their informal definitions can be interpreted in many ways. Complete metamodels of standards such as UML would greatly enhance the rigour by which the standard is implemented and understood - something that all stakeholders will benefit from.

2.6 Where do you find Metamodels?

Metamodels have been around for many years in a wide variety of different application domains and under various pseudonyms: "data model", "language schema", "data schema" are all terms we have seen. Wherever there is a need to define a language, it is common to find a metamodel. This is particularly the case for standards, which by virtue of being a standard must have a precise definition. Examples include AP233 and SysML (systems engineering), SPEM (process modelling), OSS (telecoms) and CWM (data warehousing). The Object Management Group (OMG) has been particularly involved in their use in the standards arena. One of the largest metamodels (about 200 pages long) is contained in the UML specification [uml01]. With the advent of MDA [mda] and the increasing need for standardisation across the systems development community, the number of applications of metamodels is set to grow significantly.

Finally, although many developers may view metamodels as being un-connected with their daily work, it is interesting to note that many are already using metamodels without knowing it! Many developers have already experienced the benefits of designing frameworks containing a vocabulary of language concepts. For example, developers of financial systems will use concepts such as financial transactions, accounts, and so on. In reality, they are defining a language for their domain.

2.7 Metamodeling Languages

A metamodel is written in a metamodeling language, which is described by a meta-metamodel. As described above, the aim is that the same metamodeling language (and meta-metamodel) is used to describe any number of different languages. Thus, provided that the modelling languages have been defined in the same metamodeling language, it is possible to treat their definitions in a unified manner. For example, they can be stored and manipulated in the same way, or related by mappings.

What distinguishes a metamodeling language from a general purpose programming language like Java or a modelling language like UML? The answer is that a metamodeling language is a language specifically designed to support the design of languages. An essential requirements of a metamodeling language therefore is its ability to concisely capture all aspects of a modelling language, including its syntax and semantics.

The next chapter will examine in detail the required components of a metamodeling language.

2.8 Metamodel Architectures

A metamodeling language places requirements on there being a specific metamodeling architecture. This architecture provides a framework within which some key features of a metamodel can be realised. An important property of a metamodel architecture is that it describes a classification hierarchy. Models written in the language are *instances* of the concepts that are defined in the metamodel - the structure of the instances is classified by the metamodel. Furthermore, many languages have their own notion of classification (although they need not), and the pattern is repeated until a point is reached at which further classification does not occur. This repeating pattern of classification/instantiation contributes to what is commonly known as a meta-level architecture - a concept that will be described in more detail in the next sections.

2.8.1 Traditional Metamodel Architecture

The traditional metamodel architecture, proposed by the original OMG MOF 1.X standards is based on 4 distinct meta-levels. These are as follows:

- M0** contains the data of the application (for example, the instances populating an object-oriented system at run time, or rows in relational database tables).
- M1** contains the application: the classes of an object-oriented system, or the table definitions of a relational database. This is the level at which application modeling takes place (the type or model level).
- M2** contains the metamodel that captures the language: for example, UML elements such as Class, Attribute, and Operation. This is the level at which tools operate (the metamodel or architectural level).
- M3** The meta-metamodel that describes the properties of all metamodels can exhibit. This is the level at which modeling languages and operate, providing for interchange between tools.

Each level in this hierarchy represents an instance of a classifier relationship. As shown in figure 2.2, elements at M0 are instances of classes at M1, which themselves can be viewed as instances of metamodel classes, which can be viewed as instances of meta-metamodel classes.

The unifying factor in this architecture is the meta-metamodel. It defines the simplest set of concepts required to define any metamodel of a language.

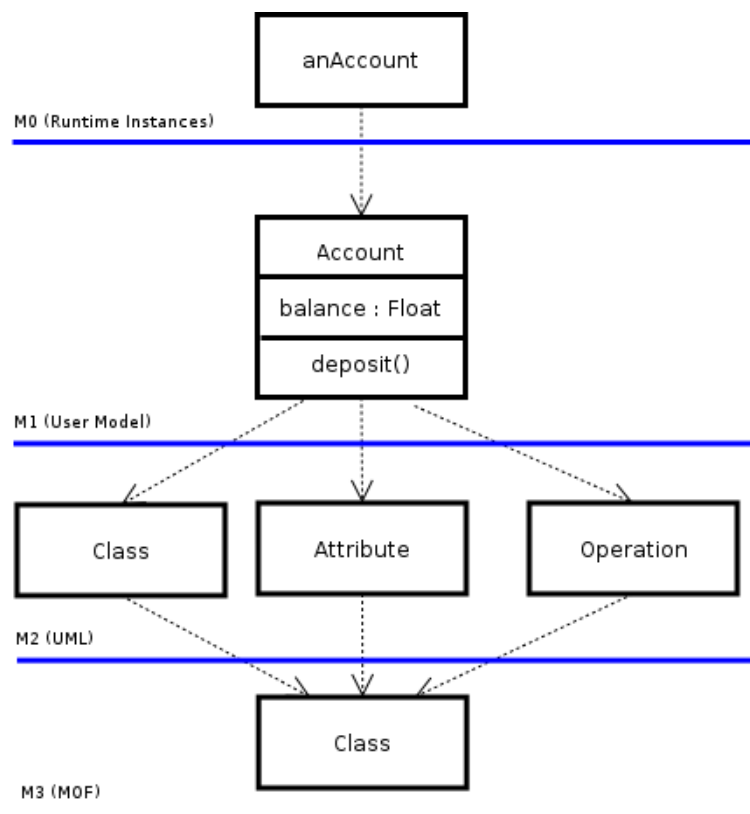

Figure 2.2: Example of the 4 Layer Meta Architecture

2.8.2 Golden Braid Metamodel Architecture

Although the 4-layer metamodel is widely cited, its use of numbering can be confusing. An alternative architecture is the golden braid architecture [Hof79]. This architecture emphasises the fact that metamodels, models and instances are all relative concepts based on the fundamental property of instantiation.

The idea was first developed in LOOPS (the early Lisp Object Oriented Programming System, and then became a feature of both ObjVLisp [Coi87] and also CLOS (the Common Lisp Object System).

Underpinning the golden braid architecture is the relationship between a Class and an Object. A Class can be instantiated to create an Object. An Object is said to be an instance of a Class. This fact can be determined through a distinct operation, `of()`, that returns the Class that the Object was created from.

In addition, a Class is also a subclass of Object. This means that a Class can also be instantiated by another Class: its meta Class. This relationship is key to the meta-architecture, as it enables an arbitrary number of meta-levels to be described through the instantiation relationship.

In practice, there will be a distinct Class that all elements in the meta-architecture are

instances of. This is the meta-meta-class, which is effectively used to bootstrap the entire metamodel architecture. This class will be defined as part of the meta-metamodel (the model of the metamodelling language used to model all languages).

In terms of the 4-layer metamodel, it is clear that it can be viewed as the result of stamping out the golden braid architecture over a number of different levels. Thus, there is no notion of a meta-metamodel: it is just a metamodel that describes models, which themselves may be metamodels.

The golden braid architecture offers a great deal of flexibility. Thus it forms the foundation of the XMF metamodelling language, which will be presented in chapter 3.

Meta Object Protocol

A related aspect of the golden braid architecture is its use of a meta-object protocol (MOP). A meta-object protocol is a set of classes and methods that allow a program to inspect the state of, and alter the behaviour of its meta-metamodel at run-time. These make it possible to easily adapt the metamodelling language to support different types of behaviours. For instance, changing the way that inheritance works, or modifying how the compiler works without having to change the code for the compiler. This adds further flexibility to the metamodelling process.

2.9 The Metamodelling Process

The task of creating a metamodel for a language is not a trivial one. It will closely match the complexity of the language being defined, so for example, a language containing rich executable capabilities will be much more complex to define than a simple static language.

However, there *is* a clearly defined process to constructing metamodels, which does at least make the task a well-defined, if iterative, process. The process has the following basic steps:

- defining abstract syntax
- defining well-formedness rules and meta-operations
- defining concrete syntax
- defining semantics
- constructing mappings to other languages

Much of the remainder of the book will focus on the detail involved in this process. Initially, we will present the tools necessary to create metamodels in the first place; the armoury of metamodelling facilities that is the metamodelling language.

2.10 Five levels of Metamodelling

We are often asked by clients how they can assess the quality of a metamodel. To help them, we have found the following five levels to be useful:

Level 1 This is the lowest level. A simple abstract syntax model must be defined, which has not been checked in a tool. The semantics of the language it defines will be informal and incomplete and there will be few, if any, well-formed rules.

Level 2 At this level, the abstract syntax model will be relatively complete. A significant number of well-formedness rules will have been defined, and some or all of the model will have been checked in a tool. Snapshots of the abstract syntax model will have been constructed and used to validate its correctness. The semantics will still be informally defined. However, there may be more in the way of analysis of the language semantics.

Level 3 The abstract syntax model will be completely tried and tested. Concrete syntax will have been defined for the language, but will only have been partially formalised. Typically, the concrete syntax will be described in terms of informal examples of the concrete syntax, as opposed to a precise concrete syntax model. Some consideration will have been given to the extensibility of the language architecture, but it will not be formalised or tested.

Level 4 At level 4, the concrete syntax of the language will have been formalised and tested. Users will be able to create models either visually and textually and check that they result in a valid instance of the abstract syntax model. The language architecture will have been refactored to facilitate reuse and extensibility. Models of semantics will have begun to appear.

Level 5 This is the topmost level. All aspects of the language will have been modelled, including its semantics. The semantic model will be executable, enabling users of the language to perform semantically rich operations on models written in the language, such as simulation, evaluation and execution. The language architecture will support good levels of reuse, it will have been proven to do so through real examples. Critically, the completed metamodel will not be reliant on any external technology - it will be a fully platform independent and self contained definition of the language that can be used 'as is' to generate or instantiate tools.

Most of the metamodels we have seen do not achieve a level greater than 2. Even international standards such as UML do not exceed level 3. Yet, reaching level 5 must be an aspiration for all language developers.

2.11 Conclusion

This chapter has outlined some of the key features of system development languages. All languages have a concrete syntax, which defines how they are presented, an abstract syntax that describes the concepts of the language, and a semantics that describes what the concepts mean. A metamodel is a model of all these different aspects of a language. Crucially, a metamodel can also be thought of as a model, written in a metamodeling language, which is itself is also described by a metamodel. This enables all metamodels to be described in the same way. This facilitates a truly unified approach to language definition.

CHAPTER 3

A METAMODELLING FACILITY

3.1 Introduction

In order to be able to construct semantically rich models of languages, a facility that fully supports language definition is required. This is known as a *metamodelling facility*. A metamodelling facility should provide the ability to capture the key features of a language, including its syntax and semantics in a unified and platform independent way, along with support for other important language design requirements such as extensibility and executability.

This chapter gives a brief introduction to a metamodelling facility called XMF (executable Metamodelling Facility). XMF extends existing standards such as MOF, OCL and QVT with rich executable metamodelling capabilities. It provides a number of languages for metamodelling, all based around a core executable meta-architecture and metamodelling framework.

XMF will form the foundation for exploring metamodelling throughout the rest of this book.

3.2 Requirements of a Metamodelling Facility

Before introducing XMF, it is important to understand some of the key requirements of a metamodelling facility.

Firstly, as discussed in the previous chapter, a metamodelling facility should provide metamodelling languages that can capture all the essential features of a language. They should include languages that can capture the abstract syntax, concrete syntax and semantics of a language. In addition, it should provide facilities for manipulating meta-models, including the ability to map them to other meta-models and extend meta-models to support new language definitions.

Secondly, it should provide a meta-architecture in which the metamodelling languages (including their semantics) are themselves described in terms of a core metamodelling language. This ensures that the languages are self defined and complete, and enables their definitions to be readily reused to create new language definitions.

Finally, to gain maximum flexibility, a metamodelling facility must be platform independent. In other words, its metamodels should be self sufficient and independent of implementation specific descriptions of the language being modelled. Thus, reliance on the implementation of the language's behaviour in a programming language or the assumption that there will be an external database that manages object creation and persistence is completely avoided.

3.2.1 XMF

XMF aims to provide a rich environment for language design that supports the key requirements of a metamodelling facility. It combines and extends a number of standard object-oriented modelling facilities to provide a minimal, but expressive, platform independent language for metamodelling. It includes the following features:

- Support for core OO modelling concepts such as packages, classes, and associations to describe language concepts and their relationship to one another.
- A constraint language, which can be used to describe well-formedness rules.
- A set of action primitives, which can be used to capture the behavioural semantics of a language and for manipulating metamodels. This turns it into a meta-programming language.
- A concrete syntax language which can be used to model the concrete syntax of any modelling language.
- A generic metamodel framework, which supports standard plug-points and machinery for expressing model element instantiation, execution, expression evaluation and reflection.
- Conformance to the golden-braid metamodel architecture described in section 2.8.2, ensuring that the language, including its semantics is completely self described.
- A collection of richer metamodelling facilities. In particular, languages for expressing mappings (both uni-directional and bi-directional) between metamodels.

The following sections present an overview of the key features of XMF. This is not a full definition, but will reference fuller descriptions of the components of the language where appropriate.

3.3 XMF Features

3.3.1 Core OO Modelling Concepts

XMF provides the standard OO modelling concepts that are supported by MOF and UML, including packages, classes and associations. These are visualised using class diagrams. Figure 3.1 shows an example of a class diagram of a simple model consisting of a package with a number of classes and associations. This model describes a simple StateMachine, where a StateMachine contains States and Transitions, and Transitions have source and target states.

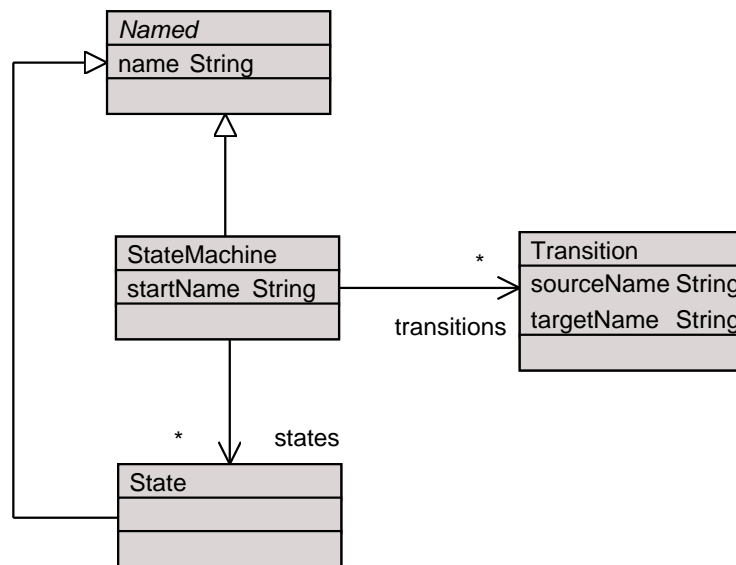

Figure 3.1: An example of a class diagram

Note that associations are defined in terms of attributes. Thus, a uni-directional association (with a single arrow head) is visual syntax for an attribute of the target type belonging to the source class. A bi-directional association (with no arrow heads) is visual syntax for a pair of attributes plus a constraint that ensures they are inverses of one another.

XMF also provides a concrete syntax for packages and classes. The equivalent concrete representation of the StateMachine class diagram shown in figure 3.1 is shown below.

```

1 @Package StateMachines
2   @Class isAbstract Named
3     @Attribute name : String end
4   end
  
```

```
5   @Class StateMachine extends Named
6     @Attribute startName : String end
7     @Attribute states : Set(State) end
8     @Attribute transitions : Set(Transition) end
9   end
10  @Class State extends Named
11  end
12  @Class Transition
13    @Attribute sourceName : String end
14    @Attribute targetName : String end
15  end
16 end
```

Line 1 shows the start of a package named StateMachines, which contains all the sub-definitions relating to StateMachines.

Line 2 contains the start of a class definition for the class Named, which is an abstract class for a named element. Line 5 is the start of the definition of the StateMachine class. It defines three attributes. The first attribute is the name of the starting state of the StateMachine. The other two attributes are states and transitions, and their types are Set(State) and Set(Transition). These types correspond to the "*" multiplicity of the equivalent association ends in the class diagram.

Lines 10 and 12 are the start of the State and Transition class definitions. The State class specialises the class Named, and therefore inherits a name attribute. A Transition has two attributes sourceName and targetName, which are the names of its source and target states.

As chapter 5 will show, the concrete representation of a modelling language should be clearly distinguished from its abstract syntax representation. Here, two different concrete syntaxes are being used to capture the same information.

3.3.2 Imports

Just as in UML and MOF, a package can be imported into another package. The result is that all referenceable elements in the imported package can be referenced by elements in the importing package. Consider the following package:

```
@Package X
  @Class Y end
end

@Package A imports X
  @Class B
    @Attribute b : Y end
  end
```

end

Because the package A imports the package X, elements in the package X can be referenced without the need to provide a full path name.

3.3.3 Constraints

It is often necessary to state well-formedness rules about concepts in a model. These rules are often made informally, for example in the context of figure 3.1 it might be useful to specify that *all transitions have unique names*. A constraint language provides a means of succinctly and unambiguously expressing complex well-formedness rules. The well-formedness rule mentioned above can be added to the class StateMachine as follows:

```
context StateMachine
  @Constraint NoTwoTransitionsWithTheSameName
  transitions->forAll(t1 |
    transitions->forAll(t2 |
      t1.name = t2.name implies t1 = t2))
end
```

Another well-formedness rule requires that the starting state must be one of the states of the state machine:

```
context StateMachine
  @Constraint ValidStartingState
  states.name->includes(startName)
end
```

The constraint language used in XMF is OCL [WK99]. The primary difference between the OCL used here and standard OCL is the use of a different syntax for declarations. In this case “@Constraint” is used as opposed to the “inv:” declaration used in standard OCL. The reason for this choice will become apparent later when we consider the need for a flexible parsing language.

3.3.4 Queries

OCL can be used to write queries. A query is used to produce a value in the context of a current object state; it does not cause any side effects. The following is an example of a query:

```

context StateMachine
  @Operation getState(n:String):State
    self.states->select(s | s.name = n)->sel
  end

```

This will filter the states of a state machine, selecting those states whose name matches the string *n*. Here, *sel*, is an in-built operation that selects a single element from a collection. Again, note that the declaration of a query differs from that in the OCL standard. Another example of query returns true if there exists a state with the name *n*:

```

context StateMachine
  @Operation isState(n:String):Boolean
    self.states->exists(s | s.name = n)
  end
end

```

3.3.5 Actions and XOCL

OCL is by design a static language and does not change the state of objects it refers to. In some situations this is a good thing because it guarantees side-effect free evaluation. However this limitation makes it very difficult to describe operational behaviour in a way which can be readily executed. Standard OCL provides pre-/post- conditions as a way of specifying the effect of an operation, however in general these cannot be executed.

An alternative approach is to augment OCL with action primitives. The XOCL (eXecutable OCL) language extends OCL with a number of key behaviour primitives. This is an essential step towards making XMF a true meta-programming environment (see chapter 7).

An example of the use of actions in XOCL can be seen in the state machine of figure 3.1. If it was required to add new states to the state machine dynamically then the following XOCL statement can be written:

```

context StateMachine
  @Operation addState(name:String)
    self.states := self.states->including(StateMachines::State(name))
  end
end

```

New instances of classes can be created by calling its *constructor*. A constructor is

an operation that has the same name as the class. It takes a sequence of values as an argument, which are then used to initialise the object's slots. In the case of the state machine, three constructors are required, one for each concrete class. The first initialises the name of a state, the second assigns a source and target state name to a transition, and the third initialises a new state machine with a name, a starting state, a set of transitions and set of states. Constructors also support getters and setters via the ? and ! notations - a ? results in the creation of a getX() operation, while a ! results in an addX() operation where X is a non-singleton attribute. Note, that if the body of the constructor is empty, the default action is to set the attribute values (slots) of the created object with the values of the parameters.

```

context State
  @Constructor(name)
  end

context Transition
  @Constructor(sourceName,targetName)
  end

context StateMachine
  @Constructor(name,startName,states,transitions) ?
  end

```

The body of the next example illustrates how OCL conditional expressions and logical operators can be combined with XOCL actions to define the operation of adding a transition. This operation takes the name of the new transition and the name of a source and target state. The isState() query is then used to check that the states belong to the StateMachine before creating a transition between them. The last line of the if statement shows how XOCL deals with the printing of strings to the console.

```

context StateMachine
  @Operation
  addTransition(source:String,target:String)
  if self.isState(source) and self.isState(target) then
    self.transitions := self.transitions->
      including(StateMachines::Transition(source,target))
  else
    "Invalid State in addTransition()".println()
  end
end

```

As this example shows, augmenting OCL with a small number of action primitives

results in a powerful and expressive programming language. Furthermore, as we will see in later chapters of this book, because the language works at the XMF level, it also provides a rich meta-programming environment that can be used to construct sophisticated facilities such as parsers, interpreters and compilers. Indeed, it is so expressive that it has been used to implement XMF itself.

3.3.6 Instantiation

A useful notation for visually representing the instances of a metamodel is a snapshot - a notation popularised by the Catalysis method [DW99]. A snapshot shows objects, the values of their slots (instances of attributes) and links (instances of associations). A snapshot of a metamodel will thus show objects and links that are instances of elements in the metamodel. The example shown in figure 3.2 is a snapshot of the StateMachine metamodel. It shows an instance of a StateMachine containing two states and three transitions.

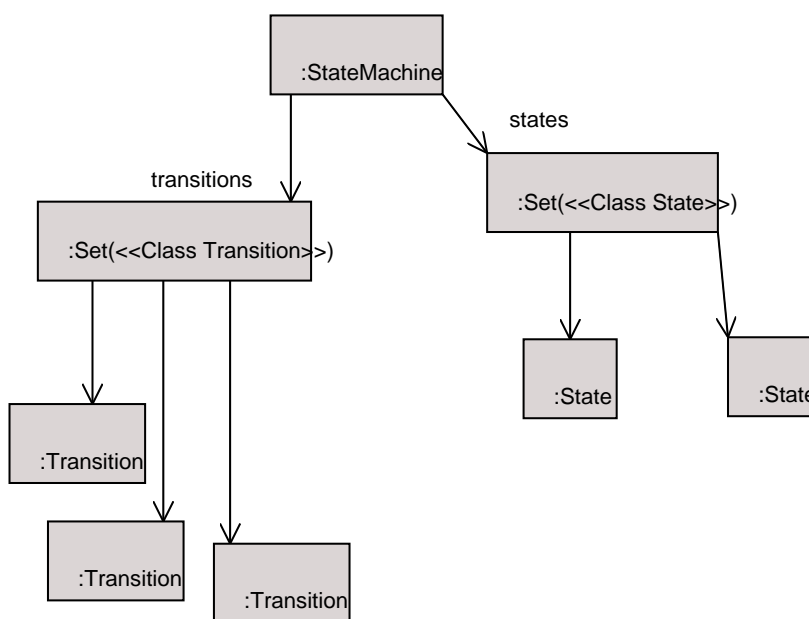

Figure 3.2: A snapshot showing an instance of the statemachine metamodel

Of course, because XMF provides an interpreter, instances of models can be easily created and tested via its interpreter console.

3.3.7 Concrete Syntax

The concrete syntax of a modelling language defines the notation that is used to present models in the language. A notation may be textual, or diagrammatical, or a mixture

of both. A key part of any metamodelling language is the ability to model both these aspects in a platform independent way, and as a result facilitate the rapid creation of parsers and diagram editors for a new language.

Textual Syntax

XMF provides a generic parser language that can be used to model the textual syntax of any language. This language, called XBNF (the reader will be starting to see a pattern to our naming conventions by now!) allows new textual constructs to be defined that can be used as input to a model parser. These new constructs to be defined as:

```
@<NAME>
  <BODY>
end
```

where <NAME> is the name of the construct and <BODY> is an XBNF expression.

An XBNF expression consists of a number of EBNF definitions within which XOCL variables are embedded, followed by an XOCL expression. When a construct is parsed, the XBNF expression is used to match each parsed element with the variables. These variables can then be used within the XOCL action to create instances of classes that populate a model of the abstract syntax of a language.

Imagine that we wish to create a concrete syntax for the simple StateMachine example. One part of this task would be to create a concrete syntax for states. This might take the form:

```
@State On
end

@State Off
end
```

The following XBNF defines the syntax for parsing states and populating instances of the class State.

```
State ::= name = Name { [ | State(name) | ] }
```

Now we have a new construct. When we type:

```
@State X end
```

we will get an instance of the class `State` named `X`. Chapter 5 will provide more detail on the use of XBNF.

Diagrammatical Syntax

In order to model the diagrammatical syntax of a modelling language, XMF provides a generic model of diagram elements such as boxes, lines, etc, that can be tailored to support specific types of diagrams. Bi-directional mappings are used to model the relationship between a specific diagram model and the model of the language's abstract syntax. This ensures that whenever changes are made to a diagram, they are reflected in the model and vice versa. By providing an interpreter (written in XMF) for displaying instances of a diagrammatical syntax model, it is possible to construct new diagram editors for a specific modelling language in very short timescales. Chapter 5 provides more detail on this aspect.

3.3.8 Mappings

Chapter 1 highlighted the fact that one important use case of languages is to transform or relate them to other languages. Mappings describe how models or programs in one language are transformed or related to models or programs in another. In order to describe these mappings, mapping languages are required.

Two types of mapping languages are included in XMF: a uni-directional pattern oriented mapping language called `XMap`, and a bi-directional synchronisation language called `XSync`.

Uni-directional Mappings

`XMap`, is a declarative, executable language for expressing uni-directional mappings that is based on pattern matching.

To illustrate the use of `XMap`, figure 3.3 shows a simple model of C++ classes which will be used as the target of a mapping from a state machine.

A C++ class is a namespace for its attributes and operations (methods). An attribute has a type, and for the purposes of this example, its type may either be another class or an enumeration type. An enumeration type has a value, which is the sequence of strings in the enumeration. An operation has a name and a body, which contains a simple string representation of the body of the operation.

A mapping from from the `StateMachine` model in figure 3.1 to the C++ in 3.3 can be defined. This maps a `StateMachine` to a C++ class, where each state in the state machine is mapped to a value in an enumerated type called `STATE`. Each transition in the state machine is mapped to a C++ operation with the same name and a body, which changes the state attribute to the target of the transition.

The mapping can be modelled in `XMap` as shown in figure 3.4. The arrows represent mappings between elements of the two languages. A mapping has a domain (or

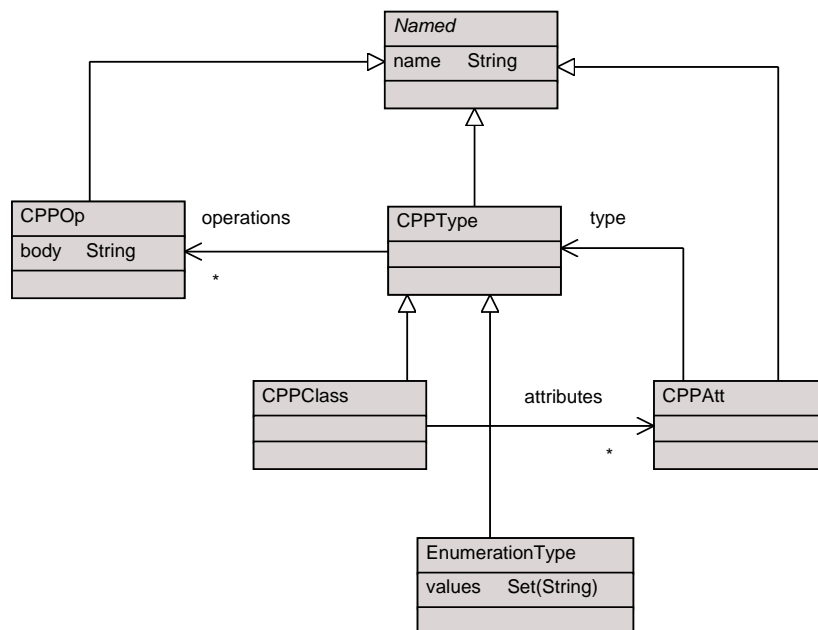

Figure 3.3: A simple model of C++ classes

domains), which is the input to the mapping, and a range, which is the output. The first mapping, SM2Class, maps a state machine to a C++ class. The second mapping, Transition2Op, maps a transition to an operation.

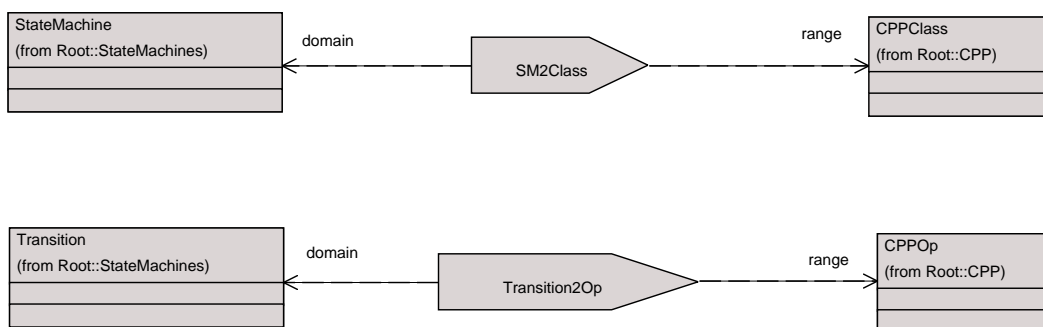

Figure 3.4: A mapping between state machines and C++ classes

In order to describe the details of the mapping, XMap uses a textual mapping language based on pattern matching. Working backwards, the definition of the mapping between a transition and an operation is as follows:

context Transition2Op

```

@Clause Transition2Op
  StateMachines::Transition
    [sourceName = S,
     targetName = T]
  do
  CPP::Operation
    [name = S+T,
     body = B]
  where
    B = "state = " + T
  end
end

```

A mapping consists of a collection of clauses, which are pattern matches between source and target objects. Whenever a source object is successfully matched to the input of the mapping, the resulting object in the do expression is generated. Variables can be used within clauses, and matched against values of slots in objects. Because XMap builds on XOCL, XOCL expressions can also be used to capture complex relationships between variables.

In this example, whenever the mapping is given a Transition with a sourceName equal to the variable S and a targetName equal to T, it will generate an instance of the class Operation, whose name is equal to the concatenation of S and T, and whose body is equal to the variable B. The where clause is used to define values of variables, and it is used here to define the variable B to be concatenation of the text "state = " with the target state name. For instance, given a transition between the states "On" and "Off", the resulting operation will have the name "OnOff" and the body "state = Off". Note that it would be quite possible to model a part of the syntax of C++ expressions, and equate B with an instance of an expression class.

The mapping between state machines and C++ classes is shown below:

```

context SM2Class
  @Clause SM2Class
    StateMachines::StateMachine
      [states = S,
       transitions = TS]
    do
    CPP::CPPClass
      [attributes =
        Set{CPP::CPPAtt
          [name = "state",
           type = T]},
       operations = O]
    where

```

```
T = CPP::EnumerationType
  [name = "STATE",
   values = S->collect(s | s.name)];
O = TS->collect(t | Transition2Op(t))
end
```

Here, a state machine with a set of states, *S*, and a set of transitions, *TS*, is mapped to a C++ class with a distinguished attribute state of type *T*, and a set of operations, *O*. The value of *T* is an `EnumerationType` whose name is "STATE" and whose values are the names of the states in *S*. Finally, the transitions are mapped to operations by iterating through the transitions in *TS* and applying the `Transition2Op` mapping.

This mapping illustrates the power of patterns in being able to match arbitrarily complex structures of objects. As shown by the class `CPPClass`, objects may be matched with nested objects to any depth. It also shows the necessity of a rich expression language like OCL for capturing the complex navigation expressions that are often encountered when constructing mappings.

Synchronised Mappings

While it is common to want to translate from one language to another, there is also a requirement to keep different models in sync. For example, an abstract syntax model will need to be kept in sync with a model of its concrete syntax, or a model may need to be synchronised with code. To achieve this, XMF provides a bi-directional mapping language called `XSync`. This enables rules to be defined that state how models at either end of a mapping must change in response to changes at the other end, thus providing a declarative language for synchronisation. This language will be explored in greater detail in chapter 8.

3.4 XMF Architecture

As outlined in the previous chapter, XMF follows the golden braid metamodel architecture, and therefore is defined in its own language. Understanding the architecture of XMF is important for many reasons. Firstly, it provides a good example of a language definition in its own right - the fact that XMF is self describing makes a strong statement about the expressibility of the language. Secondly, XMF acts as a foundation for many other metamodel definitions. For instance, it can be viewed as a subset of the UML metamodel, and many other types of modelling languages can also be viewed as extensions of the core architecture.

Figure 3.5 shows the key components of the XMF architecture. At the heart of XMF is the `XCore` metamodel. This provides the core modelling concepts of the metamodeling language (as described in section 3.3.1). This metamodel also provides a framework for

language extension (a topic discussed in more detail in chapter 9). Around it, sit the metamodels for the OCL, XOCL, XBNF, XMap and XSync languages.

The classes and relationships in these metamodels correspond precisely to the modelling features that have been used in this chapter. For example, the package and classes shown in the StateMachine abstract syntax model in figure 3.1 are concrete syntax representations of instances of the classes `XCore::Package` and `XCore::Class`. Expressions in a concrete syntax model are themselves instance of `XBNF::Grammar`, and so on.

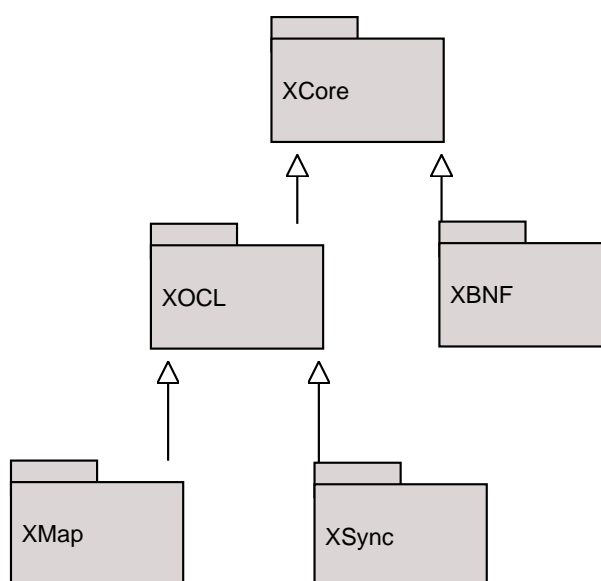

Figure 3.5: Overview of XMF Architecture

3.4.1 XCore Metamodel

As shown in figure 3.6, the classes that are defined in the `XCore` metamodel provide the core modelling concepts used in XMF such as `Class` and `Package`. As we discuss metamodeling in more detail in later chapters, many of the features of this metamodel will be discussed in detail.

There are however, some key parts of this model that are worth pointing out here:

Elements and Objects The most fundamental modelling concepts in XMF are elements and objects. Elements are the root of all modelling concepts, in other words, every type of modelling concept in XMF is an element. All elements are instances of a classifier. Elements do not have structure or state. Objects on the other hand are elements that encapsulate data values - called slots in XMF. An object's slots must conform to the name and type of the attributes of the class it is an instance of.

Performable The performable class represents the root of all modelling concepts that can be evaluated in the context of an environment (a collection of variable bindings) to return a result. An OCL expression is a good example of a performable concept.

Classification In XMF some types of modelling elements are modelled as Classifiers. A Classifier is an element that can be instantiated via the `new()` operation to create new instances. Good examples of these elements are classes and datatypes, which can be instantiated to create objects and datavalues. All elements have an `of()` operation, which returns the classifier that the element was instantiated from. For example the objects `statemachine1`, `statemachine2` will return the class `StateMachine` while the object `fido` might return the class `Dog`.

Reflection An important property of all XMF models is that classes are also objects. This apparently strange assumption means that classes can also be viewed as instances of classes. This capability is an important one, as it enables any operation that can be carried out on an object such as executing its operations, or mapping it to another object can also be applied to classes.

XOCL The XOCL class is an extension of OCL, and is the root of all imperative expressions that can change the state of a model (not shown here).

Snapshot A snapshot is a collection of elements, and may therefore include any type of element that is available in XMF.

Grammar A grammar can be evaluated in the context of sequence of tokens to generate an instance of a model.

In addition, the XCore metamodel defines a number of abstract classes that provide a framework for language design. This framework will be discussed in greater detail in chapter 9.

3.5 Relationship to Existing Metamodelling Languages

The requirement to be able to construct metamodels is not a new one, and not surprisingly a variety of languages have been proposed as metamodelling languages. The most notable of these are UML and the MOF (the Meta Object Facility). The MOF is the standard language for capturing meta-data, and goes further than the UML in meeting the requirements of a metamodelling language. Nevertheless, whilst the MOF provides many of the features necessary to define metamodels, there are a number of crucial areas in which it needs to be extended.

- The MOF does not explicitly support executable metamodelling in a platform independent way. Although it does provide OCL, this does not support the construction of operations that change the state of a model. An alternative might be

to use the Action semantics. This is a platform independent language for executing models that is currently a part of the the UML 1.5 metamodel. There are a number of problems with this language however. Firstly, it does not have a concrete syntax, which has slowed its adoption. Secondly, it is a complex language that includes many constructs that are not relevant to metamodelling, such as concurrent actions. Whilst work is ongoing to resolve the first issue, XOCL resolves both by the minimal extension of OCL, resulting in a powerful executable metaprogramming language.

- The MOF does not support an extensible grammar language. This is important in being able to model new concrete syntax grammars in MOF.
- The MOF currently is not defined fully in terms of itself. Its semantics and syntax are stated in a form (a mixture of OCL, and informal English) that prevents it from being completely self describing and self supporting.
- The MOF currently does not support mapping languages such as the XMap and XSync languages described above. Work is currently proceeding on an extension to MOF called QVT (Queries, Views, Transformations), which aims to define a language for doing uni-directional mappings, but it is unclear at this stage whether it will support all the capabilities of XMap in the short to medium term. There is unlikely to be support for synchronised mappings in the near future.

XMF aims to provide these extensions in the most concise and minimal fashion necessary to support precise, semantically rich metamodelling.

3.6 Conclusion

This chapter has described some of the essential features of XMF, an extended MOF like facility that provides the ability to define platform independent metamodels of semantically rich languages. These facilities will be used throughout the rest of this book to illustrate the metamodelling process in greater detail.

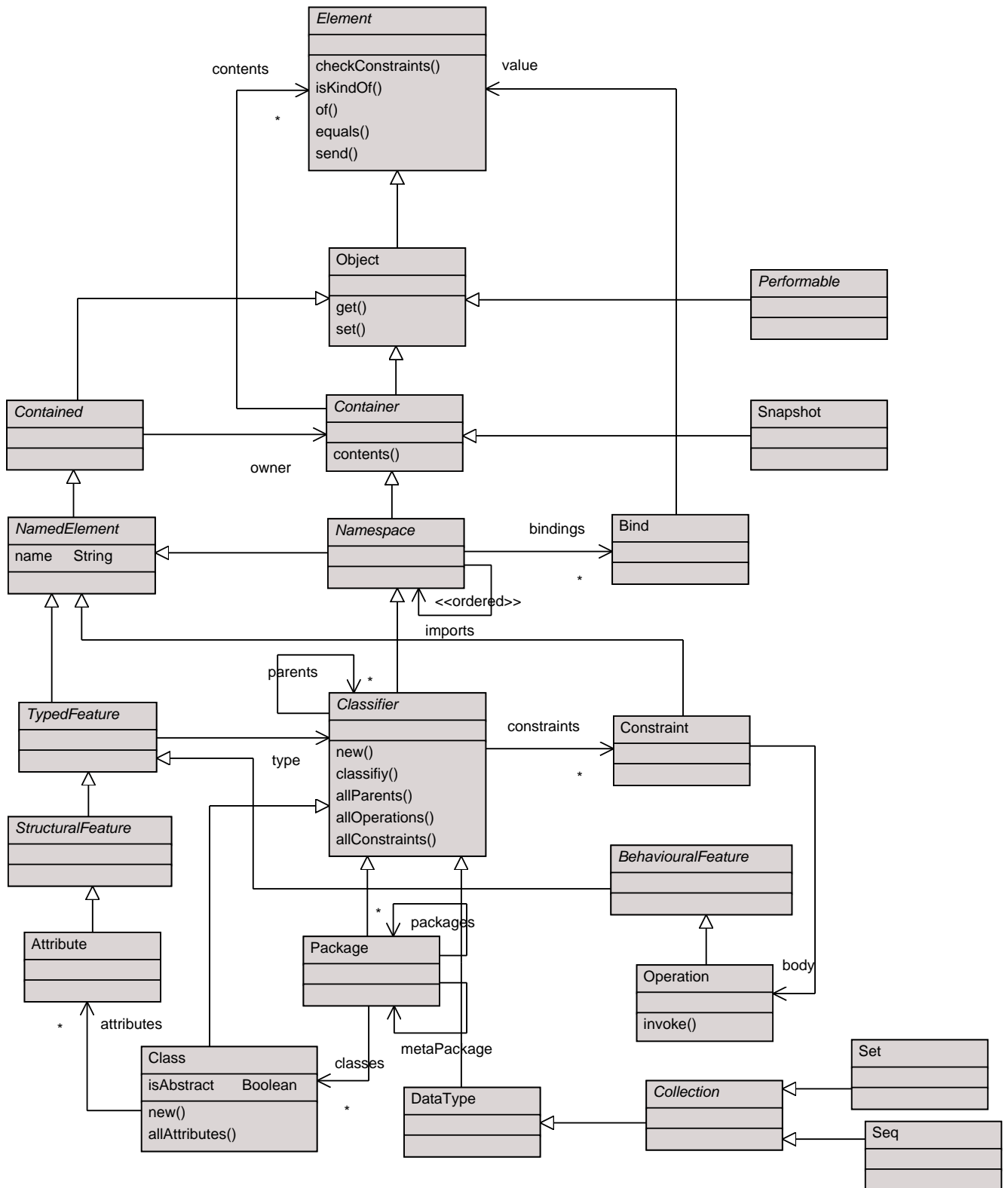

Figure 3.6: The XCore Metamodel

CHAPTER 4

ABSTRACT SYNTAX

4.1 Introduction

Just as the quintessential step in object oriented design is constructing a model of system concepts, constructing an abstract syntax model is an essential first step in the design of a modelling language. An abstract syntax model describes the concepts in the language and their relationships to each other. In addition, it also defines the rules that determine whether a model written in the language is valid or not. These are the well-formedness rules of the language.

Imagine a business modelling language suitable for modelling high level business rules about business data. An appropriate language for this domain might provide modelling concepts such as "data model", "data entity", and "business rule". In addition, there will be relationships between these concepts: a "data model" may be composed of a number of "data entities". There will also be rules describing the valid models that may be constructed in the language, for instance, "a datamodel cannot contain data entities with the same name" might be one such rule.

The concepts, relationships and rules identified during this step will provide a vocabulary and grammar for constructing models in the language. This will act as a foundation upon which all other artefacts of the language design process will be based.

This chapter describes the steps required to construct abstract syntax models, along with examples of their application to the definition of the abstract syntax model of a simple modelling language.

4.2 Modelling Abstract Syntax

As stated, the purpose of an abstract syntax model is to describe the concepts in a language and the relationships that exist between those concepts. In the context of a lan-

guage definition, a concept is anything that represents a part of the vocabulary of the language. The term abstract syntax emphasises a focus on the the abstract representation of the concepts, as opposed to their concrete representation. As a result, abstract syntax models focus on the structural relationship that exist between language concepts. Note that it is not the purpose of the abstract syntax model to describe the semantics of the language. These aspects will be described later.

An abstract syntax model should also describe the rules by which a model written in the language is deemed to be well-formed, i.e. is syntactically valid. These provide a more detailed description of the syntactical rules of the language than is possible by describing the concepts and relationships alone. Well-formedness rules are particularly useful when it comes to implementing a tool to support the language as they can be used to validate the correctness of models as they are created.

Constructing an abstract syntax model has much in common with developing an abstract grammar for a programming language, with the exception that the language is more expressive than that used in programming language design.

Abstract syntax models are written in a metamodelling language. As described in chapter 3, the metamodelling language we will use, called XMF, provides a number of modelling abstractions suitable for modelling languages. For the purposes of modelling abstract syntax only a subset of XMF will be required. This is the subset suitable for capturing the static properties of language concepts and well-formedness rules, and includes:

- Classes to describe the concepts in the language.
- Packages to partition the model into manageable chunks where necessary.
- Attributes and associations to describe the relationships between concepts.
- Constraints, written in OCL, to express the well-formedness rules.
- Operations, written in XOCL, to describe operations on the state of a model.

4.3 The Process

There are a number of stages involved in the development of an abstract syntax model: concept identification; concept modelling; model architecting; model validation and model testing. These stages are described below.

4.3.1 Concept Identification

The first stage in modelling the abstract syntax of a language is to utilise any information available to help in identifying the concepts that the language uses, and any obvious rules regarding valid and invalid models.

There are a number of useful techniques that can be used to help in this process:

- Construct a list of candidate concepts in the language. Focus on determining whether the concepts make sense as part of the language's vocabulary. In particular, identify concepts that match the following criteria:
 - Concepts that have names.
 - Concepts that contain other concepts, e.g. a class containing attributes.
 - Concepts that record information about relationships with other concepts, e.g. named associations between classes.
 - Concepts that play the role of namespaces for named concepts.
 - Concepts that exhibit a type/instance relationship.
 - Concepts that are recursively decomposed.
 - Concepts that are a part of an expression or are associated with expressions.
- Build examples of models using the language.
 - Utilise any notation that you think appropriate to represent each type of concept. Use this notation to build models of meaningful/real world examples.
 - In the case of a pre-existing language there should be resources already available to help in the identification of concepts. These may include BNF definitions of the language syntax, which can be translated into a metamodel and examples of usage. Other sources of inspiration include existing tools, which will provide automated support for building example models. Such tools may also provide additional facilities for checking valid and invalid models, which will be useful when identifying well-formedness rules or may provide more detailed examples of the language syntax.

Once some examples have been constructed, abstract away from them to identify the generic language concepts and relationships between concepts. It is often useful to annotate the examples with the modelling concepts as a precursor to this step. Examples of invalid models can also be used to help in the identification of well-formedness rules.

It is important during this process to distinguish between the concrete syntax of a language and its abstract syntax. Whilst it is common for the structure of the abstract syntax to reflect its concrete syntax, this need not be the case. For example, consider a language which provides multiple, overlapping views of a small number of core modelling concepts. In this case, the abstract syntax should reflect the core modelling concepts, and not the concrete syntax.

'Modelling the diagrams' is a common mistake made by many novice modellers. If in doubt, ask the following questions when identifying concepts:

- Does the concept have meaning, or is it there purely for presentation? If the latter, then it should be viewed as concrete syntax. An example might be a "Note", which clearly does not deserve to be modelled as an abstract syntax concept.

- Is the concept a derived concept or is it just a view on a collection of more primitive concepts? If the latter, a relationship should be defined between the richer concept and the more primitive concept.

In general, the best abstract syntax models are the simplest ones. Any complexity due to diagrammatical representation should be deferred to the concrete syntax models.

4.3.2 Use Cases

A useful technique to aid in the identification of modelling language concepts is to consider the different use cases associated with using the language. This is almost akin to writing an interface for a metamodel, i.e. a collection of operations that would be used when interacting with the metamodel. Some typical use cases might include creating and deleting model elements, but may also include semantically rich operations such as transforming or executing a model. The detailed descriptions that result from the use case analysis can then be mined for modelling language concepts.

4.3.3 Concept Modelling

Once concepts have been identified, standard object-oriented modelling features, classes, packages, and associations are applied to model the concepts in the language. There are many examples of developing conceptual models available in the literature, for instance [Lar02] devotes a significant amount of time to this subject.

In general, concepts will be described using classes, with appropriate attributes used to capture the properties of the concepts. Some concepts will have relationships to other concepts, and these will be modelled as associations. Where it makes sense to define categories of concepts, generalization can be used to separate them into more general and more specific types of concepts.

A useful strategy to apply at this stage is to reuse existing language definitions where possible. There are a number of techniques that can be used to achieve this, including:

- Extending or tailoring an existing metamodel to fit the new language. This can be achieved by specializing classes from the existing metamodel or by using package extension to import and extend whole packages of concepts.
- Utilising language patterns. A language pattern may be realised as a framework of abstract classes that capture a repeatedly used language structure, or by a package template (a parameterized package).

A full discussion of reuse techniques will be presented in chapter 9.

4.3.4 Well-formedness Rules

Once a basic model has been constructed, start identifying both legal and illegal examples of models that may be written in the language. Use this information to define a set of well-formedness rules in OCL that rule out the illegal models. When defining rules, look to identify the most general rules possible, and investigate the implications of what happens when rules are combined - sometimes rules can conflict in unexpected ways. There are many books available that can help guide this process (see [WK99] for example). Reusing existing language components can also minimise the effort involved in writing well-formedness rules, as constraints can be reused as well via inheritance.

4.3.5 Operations and Queries

Operations and queries should also be defined where appropriate. Examples of operations include general utility operations such as creating new model elements and setting attribute values, or operations that act as test harnesses. Examples of queries might include querying properties of models for use in constraints and operations, or for validation purposes. Operations that change the state of models should take any constraints into account, ensuring that if a constraint holds before the operation is invoked, it will continue to hold afterwards. Note that in general it is best to focus on using operations to test out the model - avoid at this point writing operations that implement other features of the language such as semantics.

4.3.6 Validation and Testing

It is important to validate the correctness of the abstract syntax model. Investing in this early on will pay dividends over full language design lifecycle. A useful (static) technique for doing this is to construct instances of the abstract syntax model that match those of example models. An object diagram is a useful way of capturing this information as it shows instances of classes (objects) and associations (links). There are tools available that will both help create object diagrams, and also check they are valid with respect to a model and any OCL constraints that have been defined.

The best means of testing the correctness of a language definition is to build a tool that implements it. Only then can the language be tested by end users in its entirety. The architecture of a tool that facilitates the rapid generation of tools from metamodels will be discussed in detail in later versions of this book.

4.4 Case Study

The best way to learn about metamodelling is to tackle a real example. An example of a simple, but widely known modelling language, is a StateMachine. StateMachines are

widely used as a notation for modelling the effect of state changes on an object. StateMachines are a good starting point for illustrating metamodeling as they are simple, but have enough features to exercise many facets of the metamodeling process.

Many different types of State Machine languages are described in the literature. This chapter will concentrate on a simplified form of StateMachines. Later chapters will show this language can be extended with richer modelling capabilities.

As shown in figure 4.1, a StateMachine is essentially a visual representation of states and transitions. The StateMachines described here are a form of object-oriented (OO) StateMachines. As such, they describe the state changes that can occur to an instance of a class, in this case a Library Copy.

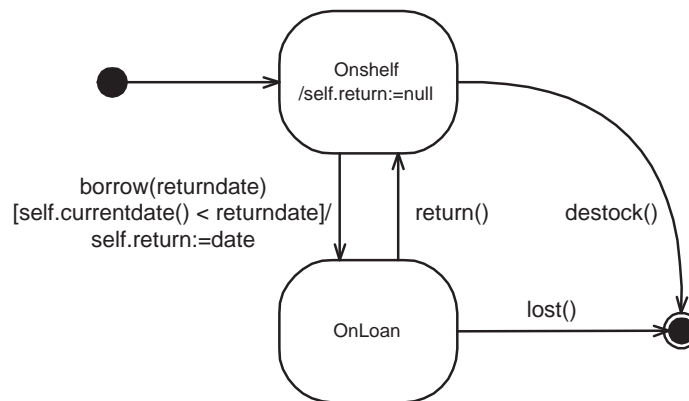

Figure 4.1: An example of a StateMachine

StateMachines have an initial state and an optional final state, which are represented by a filled circle and double filled circle respectively. In addition, StateMachines provide guards, actions and events. Guards are owned by transitions, and are boolean expressions that must evaluate to true before a transition can be invoked. Guards are represented by square brackets after an event name. An example of a guard is shown in figure 4.1 attached to the borrow event.

In order to describe the effect of a transition on the state on an object, actions can also be attached to transitions. Actions are written in an action language, which in this case is XOCL. Actions can also be attached to states, and are invoked when the state is first entered. An example of an action that sets the returndate of a Copy is shown in the figure 4.1.

Finally, events are associated with transitions via an event. Events have a name and some optional parameters. It is the receipt of an event that causes a transition to be triggered. Events can be generated by StateMachine actions.

4.4.1 Identification of Concepts

Based on the example shown in figure 4.1, the following candidate concepts can be immediately identified:

State A named representation of the state of an object at a particular point in time.

Initial State The initial state that the object is in when it is created.

Final State The final state of the object - typically when the object has been destroyed.

Transition A state change. A transition has a source and target state.

Event A named event that causes a transition to occur.

Action An executable expression that may be attached to a transition or a state. Actions are invoked whenever the transition occurs, or a state is entered.

Guard A boolean expression which must be evaluated to be true before a transition can occur.

Figure 4.2 shows the same StateMachine model 'marked up' with some of the identified concepts.

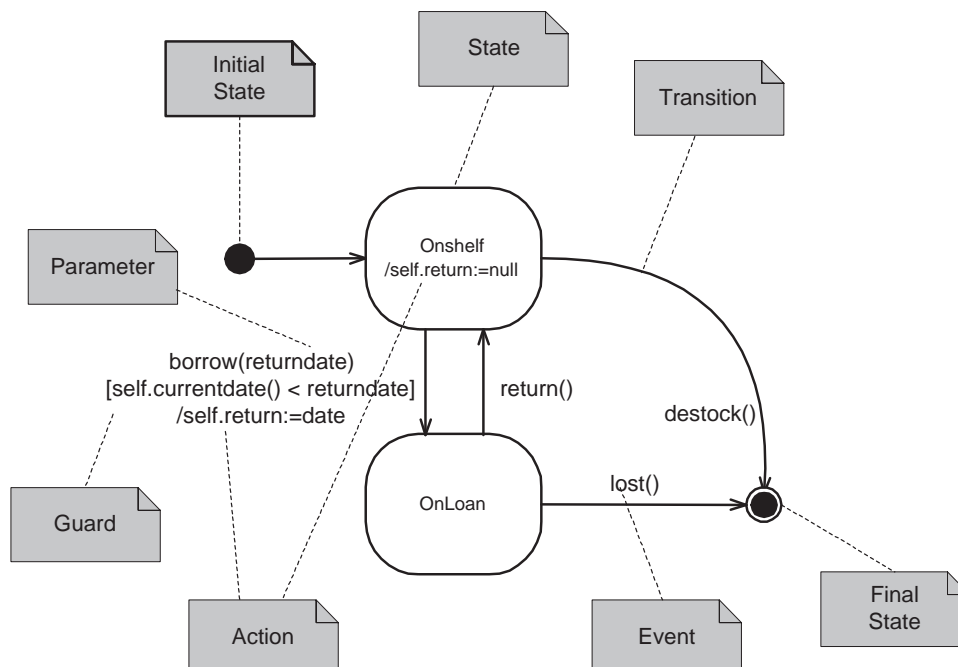

Figure 4.2: An annotated example of a StateMachine

At this stage it would also be possible to start listing the concepts that are used in the body of guards and actions, such as equality (" $=$ "), assignment (" $:=$ "). This would be a precursor to constructing models of the expression language they belong to. However, this is not necessary because we assume that the expression languages are already defined (in this case OCL and XOCL).

4.4.2 The Model

Once some candidate concepts have been identified, the next step is to construct the model.

An important question to ask at this point is whether each concept is a distinct abstract syntax concept. States and Transitions are clearly core to StateMachines, as they capture the central concepts of state and state change. However, initial states and final states could be argued not to be concepts in their own right. An initial state can be modelled as an attribute of the StateMachine, whilst a final state can be viewed as a property of the instance (the instance has been deleted).

The result of constructing the abstract syntax model is shown in figure 4.3.

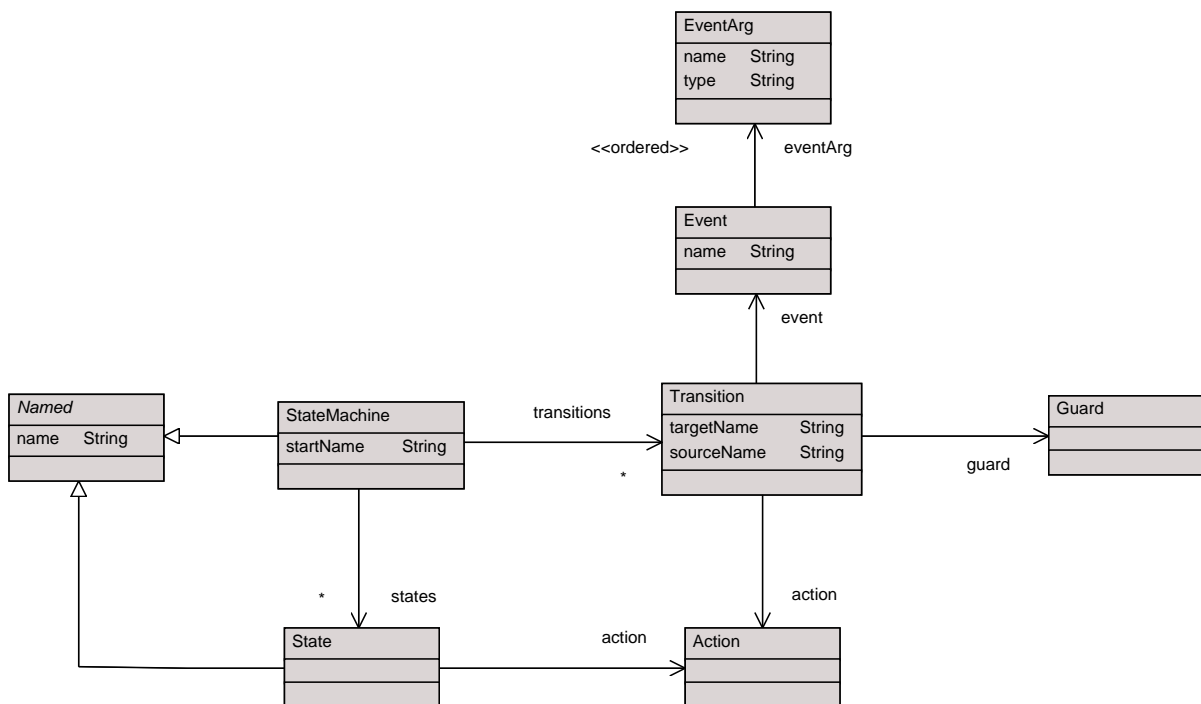

Figure 4.3: An abstract syntax metamodel for StateMachines

There are a number of points to note about the model:

- Transitions reference their source and target states by name.

- The actions and guards of states and transitions are associated with the classes Action and Guard respectively. These will be extended in the next section to deal with the language needed to construct action and guard expressions.
- The initial state of a StateMachine is represented by the attribute *startName*. This is a good example of where the abstract syntax does not match the concrete syntax one to one (in other words, the visual representation of an initial state does not have a counterpart class concept in the abstract syntax model).
- Transitions are optionally associated with an event, which has a name, and a sequence of arguments, which have a name and a type.

4.4.3 Metamodel Reuse

Once the basic concepts have been identified, the next step is to identify opportunities for reusing existing metamodeling concepts. There are two main places where this occurs.

Firstly, elements may specialise existing metamodel concepts. As described in chapter 9.2, XMF provides a framework of classes that are specifically designed for reuse when metamodeling. In this example, one type of element that can be reused is a NamedElement. Rather than inventing a new concept, we can specialise this class wherever we want a concept to have a name.

Before proceeding we must be clear about the exact properties of the concept we are specialising. A brief look at the XCore framework in section 9.5 tells us that named elements also have owners. Moreover, named elements also inherit the ability to be navigated to via pathnames (this is defined in their concrete syntax definition). While there are a number of classes that have a name, it does not make sense for them all to have owners and to be accessible via pathnames. In particular, concepts like Event, Message and their arguments types do not have this property. The classes State and StateMachine on the other hand, do. A State has a name and it is likely that it will need to know about the state machine it belongs to. A StateMachine will be owned by a class.

Another concept that we may wish to specialise is a Contained element. A contained element has an owner, but does not have a name. In this example, Transition fits that criteria.

Reuse can also be achieved by referencing existing metamodel concepts. For example, in order to precisely write guards and actions, a metamodel of an appropriate expression language will be required. It is much easier to reuse an existing metamodel that provides the necessary expression types than to build this model from scratch. In this case the XOCL metamodel provides a good match: it includes both constraint style (OCL) expressions and action style expressions.

Thus, the model needs to be changed so that actions and guards are associated with XOCL expressions. A convenient way of achieving this is to use the class XMF::Operation to encapsulate the expression bodies. The resulting metamodel is shown in figure 4.4

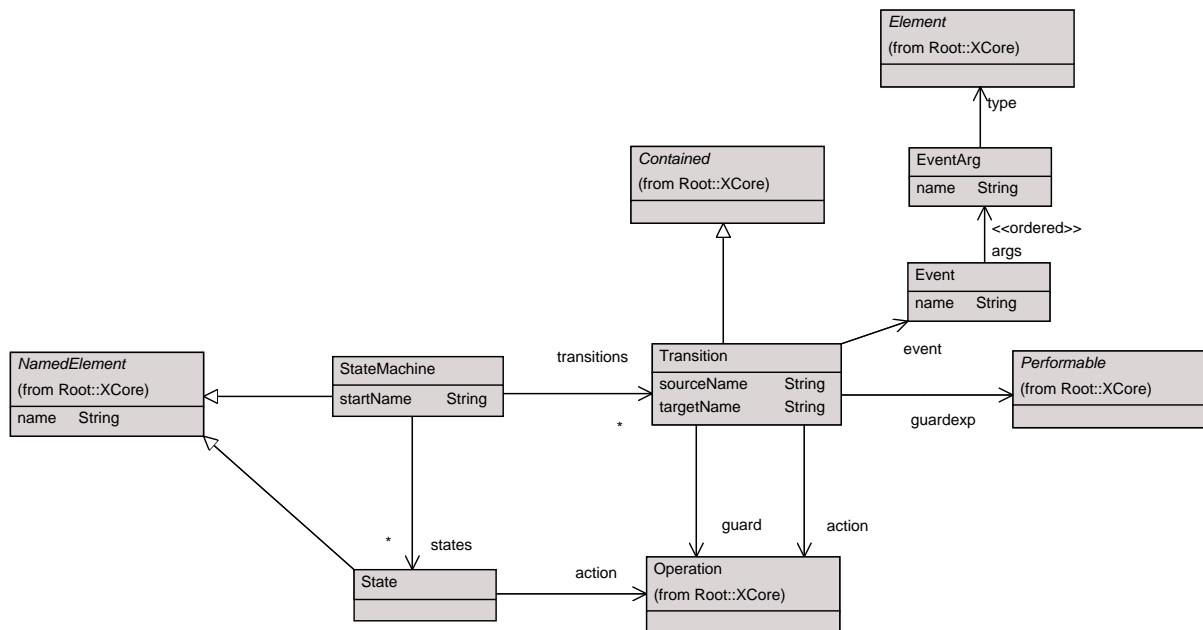

Figure 4.4: An extended abstract syntax metamodel for StateMachines

Finally, the type of a parameter is replaced with the class `XMF::Element`. This enables parameter types to be of any XMF type, thereby reusing XMF's type machinery.

4.4.4 Well-formedness Rules

Once the concepts and relationship in the StateMachine language have been identified, well-formedness rules can be defined. Here are some examples:

Firstly, it must be the case that all states have a unique names:

```

context StateMachine
  @Constraint StatesHaveUniqueNames
  states->forall(s1 |
    states->forall(s2 |
      s1.name = s2.name implies s1 = s2))
end

```

Secondly, the initial state of the StateMachine must be one the StateMachine's states:

```

context StateMachine
  @Constraint StatesIncludeInitialState
  states->exists(s | s.name = startName)

```

end

4.4.5 Operations

Next, operations are added that will be used to create elements of a StateMachine. The first adds a state to a StateMachine and sets the owner of State to be the StateMachine. Note the operation cannot be invoked if the name of the new State conflicts with an existing state in the StateMachine, thus ensuring that StatesHaveUniqueNames constraint is not broken.

```
context StateMachine
  @Operation addState(state:StateMachines::State)
  if not self.states->exists(s | s.name = state.name) then
    self.states := states->including(state);
    self.state.owner := self
  else
    self.error("Cannot add a state that already exists")
  end
end
```

The second adds a transition (again setting the owner to be the StateMachine):

```
context StateMachine
  @Operation addTransition(transition:StateMachines::Transition)
  self.transitions := transitions->including(transition);
  self.transition.owner := self
end
```

Similar operations will need to be defined for deleting states and transitions.

The following query operations are defined. The first returns the initial state of the StateMachine provided that it exists, or returns an error. An error is a pre-defined operation on XMF elements that is used to report errors.

```
context StateMachine
  @Operation startingState()
  if states->exists(s | s.name = startName) then
    states->select(s | s.name = startName)->sel
  else
    self.error("Cannot find starting state: " + startName)
  end
end
```

The second returns the set of transitions starting from a particular state:

```

context StateMachine
  @Operation transitionsFrom(state:String)
  transitions->select(t | t.sourceName = state)
end

```

4.4.6 Validating the StateMachine Metamodel

In figure 4.5 a partial snapshot corresponding to the StateMachine in figure 4.1 is shown.

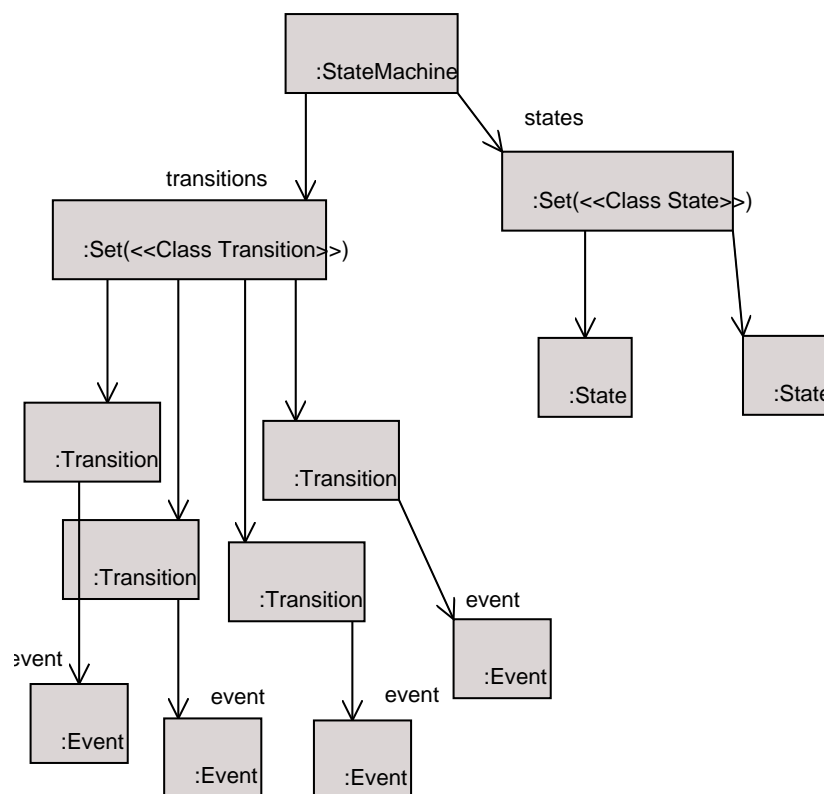

Figure 4.5: A snapshot (object diagram) corresponding to figure 4.1

A number of different properties of the model can be usefully tested by snapshots. These include checking the well-formedness rules and query operations by running them against the snapshot.

However, this is about as far as we can go. At this point, the model is just a model of the abstract syntax and nothing more. Other aspects of the StateMachine language, including its concrete syntax and semantics, must be modelled before a precise, self contained language definition is obtained. These aspects will be explored in the following chapters.

4.5 Conclusion

This chapter has examined the process and modelling language required to model the abstract syntax of languages. The result is a definition of the concepts in a language and the relationship and rules that govern them. However, this is just a first step towards a complete definition of the language. Only once the concrete syntax and semantics of the language are modelled does it become a complete definition of the StateMachine language.

CHAPTER 5

CONCRETE SYNTAX

5.1 Introduction

Although an abstract syntax describes the underlying vocabulary and grammar of a language, it does not define how the abstract syntax is presented to the end user, that detail is described by a concrete syntax which can either be in diagrammatic or textual form. Many contemporary modelling languages use diagrammatic concrete syntax such as state machines and class diagrams, but diagrammatic syntaxes are often limited by the real estate of the user's display and some languages such as OCL have only a textual syntax.

Dealing with concrete syntax is a two stage process. The first stage involves interpreting the syntax and ensuring that it is valid. In the second stage, the concrete syntax is used to build the abstract syntax. These stages are equally applicable to both text and diagrams although there is an important difference in the way the concrete syntaxes are constructed by the end user. Diagrams are commonly constructed interactively and therefore incrementally, consequently the syntax must be interpreted in parallel to the user's interaction. On the other hand, textual syntax is usually interpreted in batch, the user constructs the complete model using the syntax and only then is it passed to the interpreter. This style of processing syntax is comparable to programming language compilers and interpreters.

The first part of this chapter describes the XBNF textual parser component of XMF and demonstrates how it can be used to realise the interpreting of text based concrete syntax and the construction of the abstract syntax. The second part of the chapter discusses how diagrammatic syntax is defined and how it is linked and synchronised with abstract syntax using XSync.

5.2 Textual Syntax

In this section we describe the parsing of text using XBNF. The XBNF language is based on EBNF which is a popular approach to describing the grammars of languages, because of this the grammars of most textual languages are easily available (Ada, Java, SQL, for example). Once a grammar for a language has been defined, the next step is to define how abstract syntax is constructed (or synthesised) as a result of the parsing input using the grammar. Although the approach described in this section is oriented towards producing the type of abstract syntax structures described in chapter 4, the mechanisms used are generic one and can be generally applied to a wide range of text parsing problems.

5.2.1 Parsing text using EBNF

The interpretation of textual syntax involves defining the rules by which streams of ASCII characters are deemed to be valid concrete syntax. These rules are commonly referred to as the grammar rules of a language. A grammar consists of a collection of clauses of the form:

```
NAME ::= RULE
```

where a RULE defines how to recognise a sequence of input characters. An example of a rule is the following:

```
Calculator ::= Mult '='
```

which defines that to satisfy the rule Calculator the input characters must first satisfy Mult, which is a non-terminal because it refers to another rule, followed by a terminal '='. A terminal is understood to be a sequence of characters in quotes. A Mult is a multiplicative expression possibly involving the multiplicity (*) and division (/) operators, the grammar for Mult is defined as:

```
Mult ::= Add ('*' Mult | '/' Mult)
```

The rule for Mult shows a number of typical grammar features. A Mult is successfully recognised when an Add is recognised followed by an optional '*' or '/' operator. The choice is described by separating the two or more options (terminals or non-terminals) using the vertical bar. Consequently this rule defines three possibilities:

- The input stream satisfies Add followed by a '*' followed by Mult.
- The input stream satisfies Add followed by a '/' followed by Mult.
- The input stream satisfies Add.

The grammar for Add is the same as Mult except Add recognises addition expressions:

```
Add ::= Number ('+' Add | '-' Add)
```

5.2.2 Parsing text using XBNF

XBNF augments EBNF with details concerned with managing multiple grammars. Firstly it is necessary to put grammars somewhere so that they can be used when required, secondly it is necessary to be able to specify given an ASCII stream which grammar should be used to understand the stream. In order to illustrate XBNF we will define the grammar for a state machine. The following is an example of a state machine's textual concrete syntax:

```
@StateMachine (Off)
  @State Off
  end

  @State On
  end

  @Transition (On,Off)
  end

  @Transition (Off,On)
  end
end
```

As in this example, all textual syntax dealt with by XMF is littered with @ symbols. These symbols are special because the word immediately after the symbol indicates where the top level grammar rules can be found which validate the syntax immediately after the declaration. In the above example, this specifies that the syntax (*Off*) should be understood in the context of the grammar defined in class *StateMachine*, that *Off* and *On* should be understood in terms of the grammar defined in the class *State* and that (*On,Off*) and (*Off,On*) should be interpreted in the context of the grammar defined in the class *Transition*. The three classes to interpret this collective syntax is defined below¹:

```
@Class StateMachine
  @Grammar
    StateMachine ::= '(' startName = Name ')' elements = Exp*
  end
end

@Class State
  @Grammar
    State ::= name = Name
```

¹Note that *Name* is a built in rule which matches any combination of alphanumeric characters

```

    end
end

@Class Transition
  @Grammar
    Transition ::= '(' sourceName = Name ',' targetName = Name ')'
  end
end

```

The grammar rules are embedded in the body of the *@Grammar*. These say that the textual syntax for a *StateMachine* consists of a *Name* (the name of the starting state) followed by zero or more *Exp* referring to the whichever grammar rules parses the body of the *StateMachine* (which is likely to be *State* or *Transition*). A *State* consists only of a *Name* (its name). A *Transition* consists of two names parsing the source and target state of the transition.

The @ grammar reference symbol as a means of referring to different grammars offers massive flexibility since language grammars can be mixed. It is possible to use the state machine language in the context of regular XOCL expressions for example (since XOCL and all XMF languages are defined using precisely the method outlined in this book). Sometimes however the @ symbol can be inconvenient when an existing language must be parsed since the text of that language must be augmented with the @ grammar reference symbol in order to parse it using XBNF. In this case it is possible to collectively define the grammar rules such that only a single top-level @ is required. For instance, consider the case of the following state machine grammar definition:

```

@Class StateMachine
  @Grammar
    StateMachine ::= '(' startName = Name ')' elements = (State |
      Transition)*.

    State ::= name = Name.

    Transition ::= '(' sourceName = Name ',' targetName = Name ')'.
  end
end

```

This grammar will support the parsing of the following syntax which has a single @ denoting the single required rule:

```

@StateMachine (Off)
  State Off
end

```

```
State On
end

Transition(On,Off)
end

Transition(Off,On)
end
end
```

5.2.3 Building Abstract Syntax

Having established whether a given textual syntax is valid, the next step is to model the construction of the abstract syntax. The steps taken by XBNF are illustrated in figure 5.1. As can be seen from this, XBNF produces XMF abstract syntax as a result of the parse and evaluates this to produce an abstract syntax model. At first glance this may seem confusing since there are two different types of abstract syntax and an evaluation step from one to the other. The need for this is based on the generality of the XBNF mechanisms, XBNF can be used in the context of a more conventional interpreter where textual input such as $5 + 5$ evaluates to the result 10. The grammar produces the abstract syntax of $5 + 5$ and the evaluator evaluates this abstract syntax to produce the value 10. In the definition of a model based language however, the value required from the evaluator is the model based abstract syntax of the type defined in chapter 4. In which case the grammar rules must produce XMF abstract syntax that evaluates to the value of model based abstract syntax. To avoid confusion, for the remainder of this chapter XMF abstract syntax will be referred to as *abstract syntax* and abstract syntax model will be referred to as *abstract syntax value*.

Raw abstract syntax can be defined as a result of grammar rules however defining this can be verbose and time consuming, an alternative is to use a powerful XMF tool which eases the process of this definition. This tool is designed around the observation that it is often the case that the required abstract syntax can be expressed in terms of an existing XMF based concrete syntax. For example the state machine abstract syntax value described in chapter 4 is expressed in terms of the syntax for classes and operations. The tool, called quasi-quoting, allows the description of new concrete syntax in terms of old concrete syntax, because most languages tend to be built from existing languages (and rarely from scratch) we deal with this method in detail in the next sections.

Quasi-quoting

Rather than describing the abstract syntax that gives rise to the abstract syntax value, quasi-quotes enables the user to instead say "give me the abstract abstract syntax that

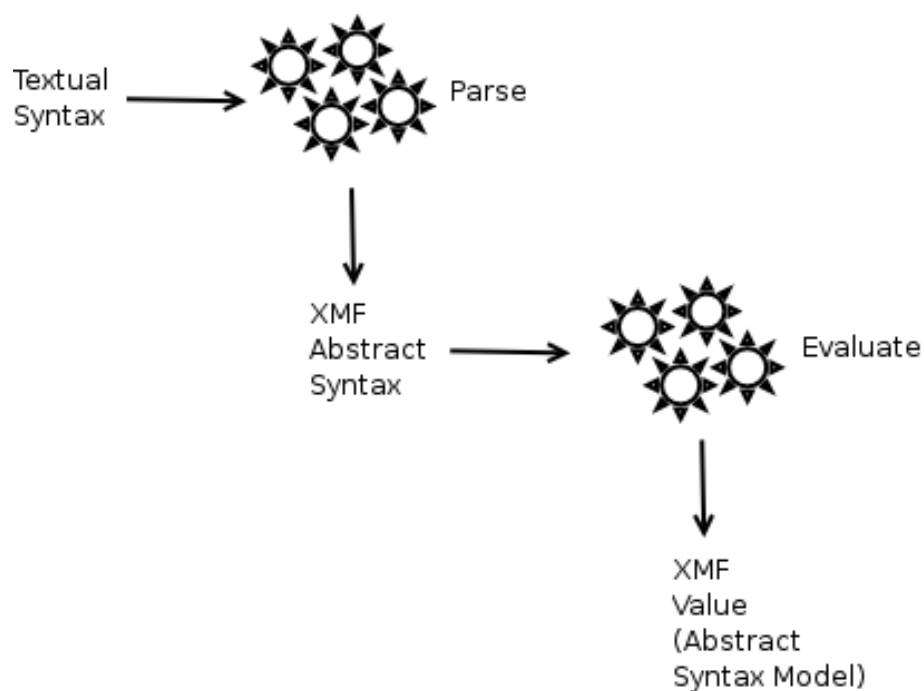

Figure 5.1: The process of translating textual syntax to model-based abstract syntax

you get if you parsed this existing concrete syntax”. Quasi-quotes can be used to find the abstract syntax of any concrete textual syntax by enclosing the textual syntax as exemplified in the following way:

```
[| ... |]
```

For example, the following quasi-quotes will return the abstract syntax for *StateMachine*:

```
[| StateMachine() |]
```

Often the abstract syntax returned by quasi-quotes is not the required abstract syntax, instead it is desirable to be able to *drop* values into this which have been parsed and stored by the grammar rules. Syntactically a drop is enclosed by `<` and `>`. For example, the grammar for *StateMachine* parses the starting state *startName* which, when evaluated to produce the abstract syntax, should be passed to the constructor of *StateMachine*. This is done in the following way (ignoring *elements* for the time being):

```
context StateMachine
```

```
@Grammar
  StateMachine ::= '(' startName = Name ')' elements = Exp {
    [| StateMachine(<startName>) end |]
  }.
end
```

The same approach can be used to construct the abstract syntax for a state:

```
context State
```

```
@Grammar
  State ::= name = Name {
    [| State(<name>) end |]
  }.
end
```

Here the abstract syntax has the *name* dropped into the quasi-quotes, and the body of an operation. When this is evaluated to produce the abstract syntax value, these will be passed as parameters to the constructor of *State*. *Transition* and *StateMachine* can be defined in a similar way:

```
context Transition
```

```
@Grammar
  Transition ::= '(' sourceName = Name ',' targetName = Name ')' {
    [| Transition(<sourceName>,<targetName>) |]
  }.
end
```

```
context StateMachine
```

```
@Grammar
  StateMachine ::= '(' startName = Name ')' elements = Exp* {
    [| StateMachine(<startName>,<elements>) |]
  }.
end
```

Sugar

One of the side effects of using the quasi-quoting mechanism, as illustrated in the previous section, or creating abstract syntax directly, is that the original concrete syntax is lost since the translation does not record details of the original concrete syntax. Often it is desirable to be able to make the transition back from the abstract syntax to the concrete syntax, a good example of where this is useful is during the process of debugging a model. In order to support this XMF provides a further tool called *Sugar*². Instead of the grammar rules constructing the abstract syntax directly, they instantiate classes of type *Sugar* which then create the abstract syntax and provide methods for doing other things such as translating the consequent abstract syntax back to the concrete syntax.

An example of *Sugar* class is illustrated below:

```
@Class StateSugar extends Sugar
  @Attribute name : String end

  @Constructor(name) end

  @Operation desugar()
    [| State(<name>) |]
  end

  @Operation pprint(out,indent)
    format(out,"@State ~S",Seq{name})
  end
end
```

Any class extending *Sugar* must override the abstract operation *desugar()* which should return the required abstract syntax. The additional (and optional) method *pprint* is used to *pretty print* the original concrete syntax from the abstract syntax. This method takes an output stream (to print the text to) and an indent variable which denotes the current indentation of the textual syntax. In the above example, the text *@State* and the state name is sent to the output stream.

The grammar rule constructs *Sugar* classes as appropriate:

```
context State
  @Grammar
    State ::= name = Name action = Exp* {
      StateSugar(name,action)
```

²The process of *Sugaring* and *Desugaring* (often used in programming language theory) is used to describe the process of translating to and from new syntax using existing syntax. It captures the idea that the new syntax is not adding any fundamentally new semantics to the language, merely making existing syntax more palatable (or sweeter!) to the end user of the syntax.

```
} .  
end
```

5.3 Diagrammatic Syntax

As indicated in the introduction to this chapter, the major difference between diagrammatic syntax and textual syntax is that diagrammatic syntax is interpreted incrementally whereas textual syntax is interpreted in batch. This presents a different set of challenges for diagrammatic syntax to that of its textual counterpart, the incremental nature of its construction must be taken into account when devising an architecture in order to support it. A further challenge for diagrammatic languages is being able to specify the valid concrete syntax of the diagram in a textual language such as XMF. As we have discussed in the previous section, this is well understood for textual syntax using notations such as EBNF, but for diagrams it is less clear how the equivalent can be achieved. In the following sections we discuss the XMF approach to doing this.

5.3.1 Parsing Diagrams

In order to describe how to interpret a diagram, we must first define what it means to be a diagram at some (useful) level of abstraction. This is achieved by forming a model of diagrams in XMF as illustrated in figure 5.2, this model shares many parallels with OMG's diagram interchange model []. A key characteristics which it shares with the diagram interchange model is that its generality enables it to capture the concrete syntax concepts, and the relationship between these, for a broad spectrum of diagram types ranging from sequence diagrams to state machines to class diagrams.

Clearly the model shown in figure 5.2 does abstract from details that may be important such as their rendering and the paradigm of interaction that gives rise to their state being changed. This detail is outside the scope of the model, but is an important component of realising this approach in the context of a real tooling environment. One approach to dealing with this detail is to interface to some external tool that understands how to render the concepts and respond to user interaction. Since this is an implementation detail we do not dwell on it here, instead we make the assumption that the instantiating of concepts in figure 5.2 results in the concrete display of the denoted element. Moreover we assume that interaction with the concrete display, moving a node for example, results in the state of its model-based counterpart being updated. A suitable implementation of this scenario can be black boxed such that new diagram types are constructed only as a result of dealing with the model.

Specific diagramming types are described by specialising the model of diagrams, this is shown in figure 5.3 for state machines. In this a *StateDiagram* is a type of *Diagram*, the *Graph* of a *StateMachine* is constrained to contain *TransitionEdges* and *StateNodes* (which

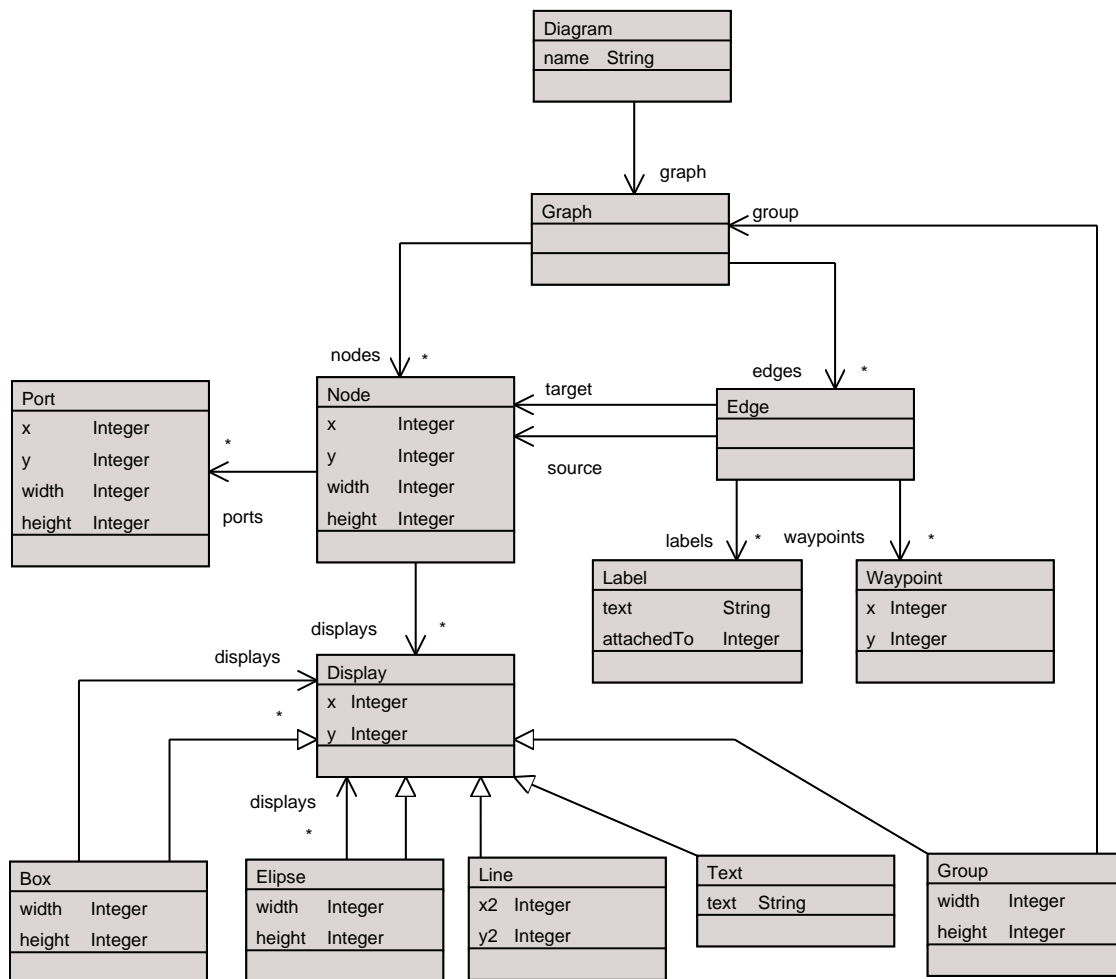

Figure 5.2: A model of diagrams

are specialised *Edges* and *Nodes* respectively). A *TransitionEdge* is constrained to be the *source* and *target* of *StateNodes*, and a *StateNode* is displayed using an *Elipse*.

5.3.2 Building Abstract Syntax

As the user interactively constructs instances of the model of diagrams the abstract syntax should be concurrently constructed as appropriate. One approach to achieving this is to embed operations in the concrete syntax which generate abstract syntax on the fly. Although this approach would work well in practice, a deficiency is that it couples the abstract syntax to the concrete syntax. In practice it may be desirable to have a single diagram type generating different abstract syntaxes under different circumstances. A much more flexible approach is to form a mapping between the concrete syntax and

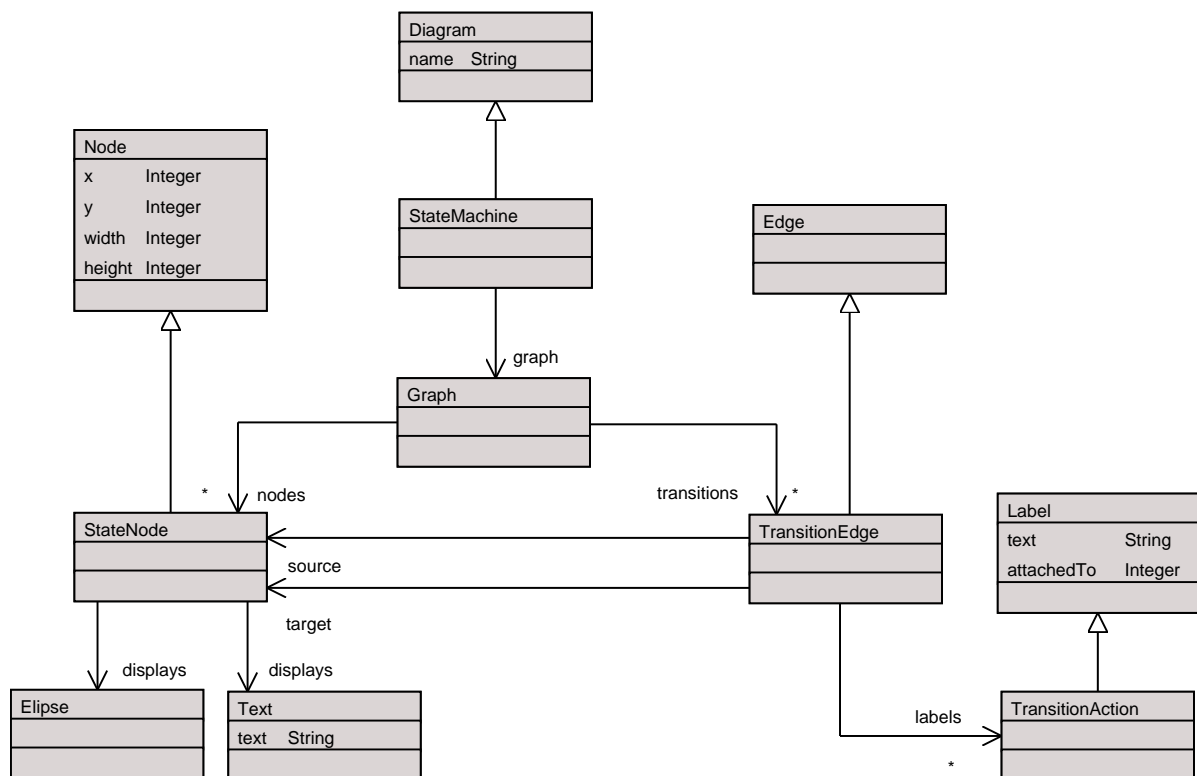

Figure 5.3: Specialising the model of diagrams for state machines

abstract syntax which neither side know about. This scenario is illustrated in figure 5.4.



Figure 5.4: Mapping between diagram syntax and abstract syntax

In this the mapping listens to changes in the concrete syntax for changes that impact the abstract syntax and updates the abstract syntax appropriately. Given a *StateDiagram* and an *StateMachine*:

```
@Class StateDiagram extends Diagram
...
end
```

```

@Class StateMachine

  @Attribute startName : String end
  @Attribute states : Set(State) end
  @Attribute transitions : Set(Transition) end

  ...
end

```

A mapping is defined:

```

@Class StateMachineXStateDiagram

  @Attribute statemachine      : StateMachine end
  @Attribute diagram          : StateDiagram end
  @Attribute stateMaps        : Set(StateXNode) end
  @Attribute transitionMaps    : Set(TransitionXTransitionEdge) end
  ...

```

The mapping knows about the top level constructs of the statemachine's concrete and abstract syntax. When the mapping is constructed, a listener (or daemon) is placed on the *diagram's* graph, such that when a state added or removed, a method is invoked adding or removing a *State* from the abstract syntax *statemachine*:

```

@Constructor (statemachine, diagram)
  self.addDaemons()
end

@Operation checkDiagramDaemons()
  if not diagram.hasDaemonNamed("stateAdded") then
    @SlotValueChanged + stateAdded(
      diagram.graph, "nodes", newStateNode)
    self.stateNodeAdded(newStateNode)
  end
end;
if not diagram.hasDaemonNamed("stateRemoved") then
  @SlotValueChanged - stateRemoved(
    diagram.graph, "nodes", removedStateNode)
  self.stateNodeAdded(removedStateNode)
end
end

```

end

Listeners to detect the addition and removal of transitions are implemented in a similar way. The methods for adding and removing the *State* from the *statemachine* are specified as follows:

```

@Operation stateNodeAdded(newStateNode)
  if not stateMaps->exists(map | map.stateNode = newStateNode)
  then
    let name = self.newStateName() then
      state = State(name)
      in newStateNode.setName(name);
      self.add(StateXNode(state, newStateNode, self));
      statemachine.add(state)
    end
  end
end

@Operation classRemoved(class)
  @Find(map, classMaps)
  when map.class = class
  do self.remove(map);
  map.node.delete()
  end
end
end

```

The style of mapping concrete syntax to abstract syntax can be nested within containment relationships such that a new mapping is generated from a listener, which in turn listens to the newly mapped elements and generates new mappings as concrete syntax elements are created ... This gives rise to the hierarchy exemplified in figure 5.5 where only the top level mapping between concrete syntax element *A* and abstract syntax element *A'* is generated statically (i.e. not via listeners).

5.3.3 Building Diagrams from Abstract Syntax

The approach to mapping concrete syntax to abstract syntax described in the previous section can equally be applied to the inverse mapping of abstract syntax to concrete syntax, potentially this can be done simultaneously so that changes to either side of the mapping result in an update to the other. Such bi-directional mappings are particularly desirable in a scenario where an abstract syntax is the source of multiple concrete syntaxes (which are effectively views on the abstract syntax) a change to one concrete

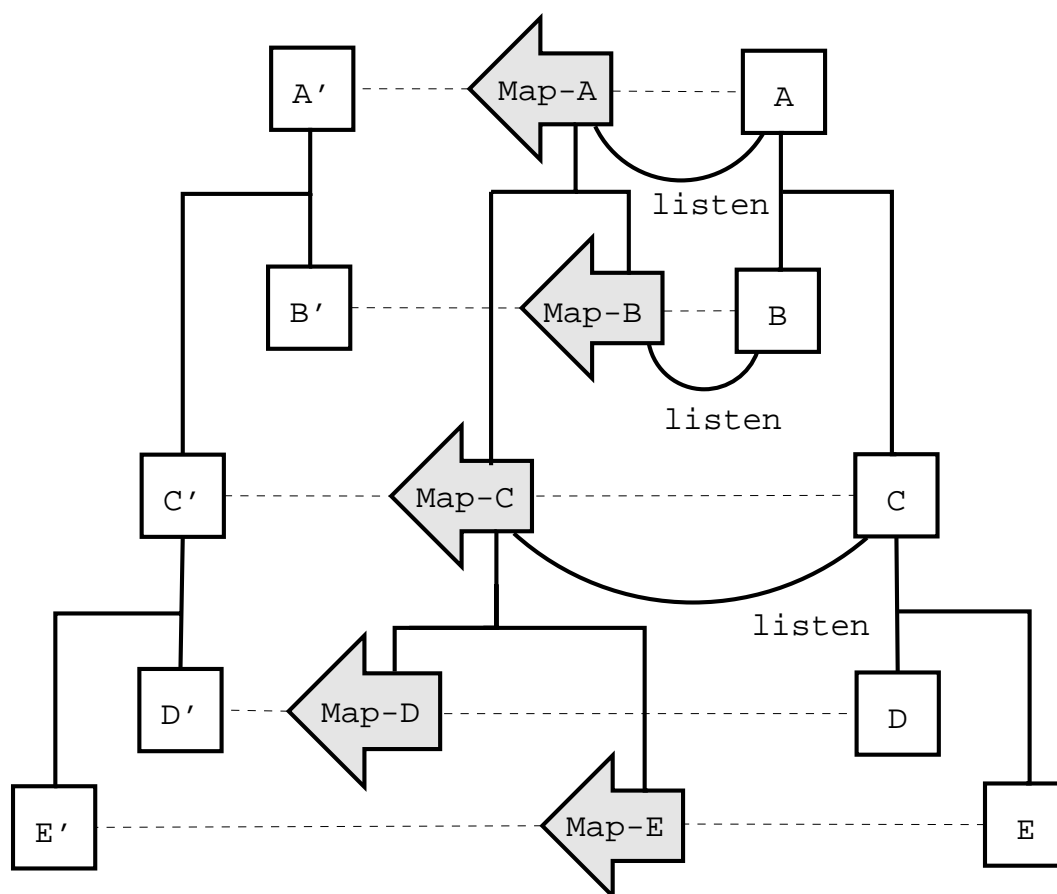

Figure 5.5: An example of how listeners can generate mappings which can themselves listen and generate mappings

syntax will propagate the change to another concrete syntax via the shared abstract syntax. A screenshot of the XMF-Mosaic using this style of bi-directional concrete syntax definition is shown in 5.6.

5.4 Conclusion

In order to support the rapid creation of concrete syntaxes for a modelling language, higher level modelling languages are required. This chapter has described XBNF, a language for modelling textual syntaxes. In order to model diagrammatic syntaxes, a framework for modelling common diagrammatic primitives is required, along with a language for describing how the diagrammatic syntax is synchronised with the underlying abstract syntax model of the language. In chapter 8 XSync is introduced which is a declarative language for defining the synchronisation of data and languages. XSync can

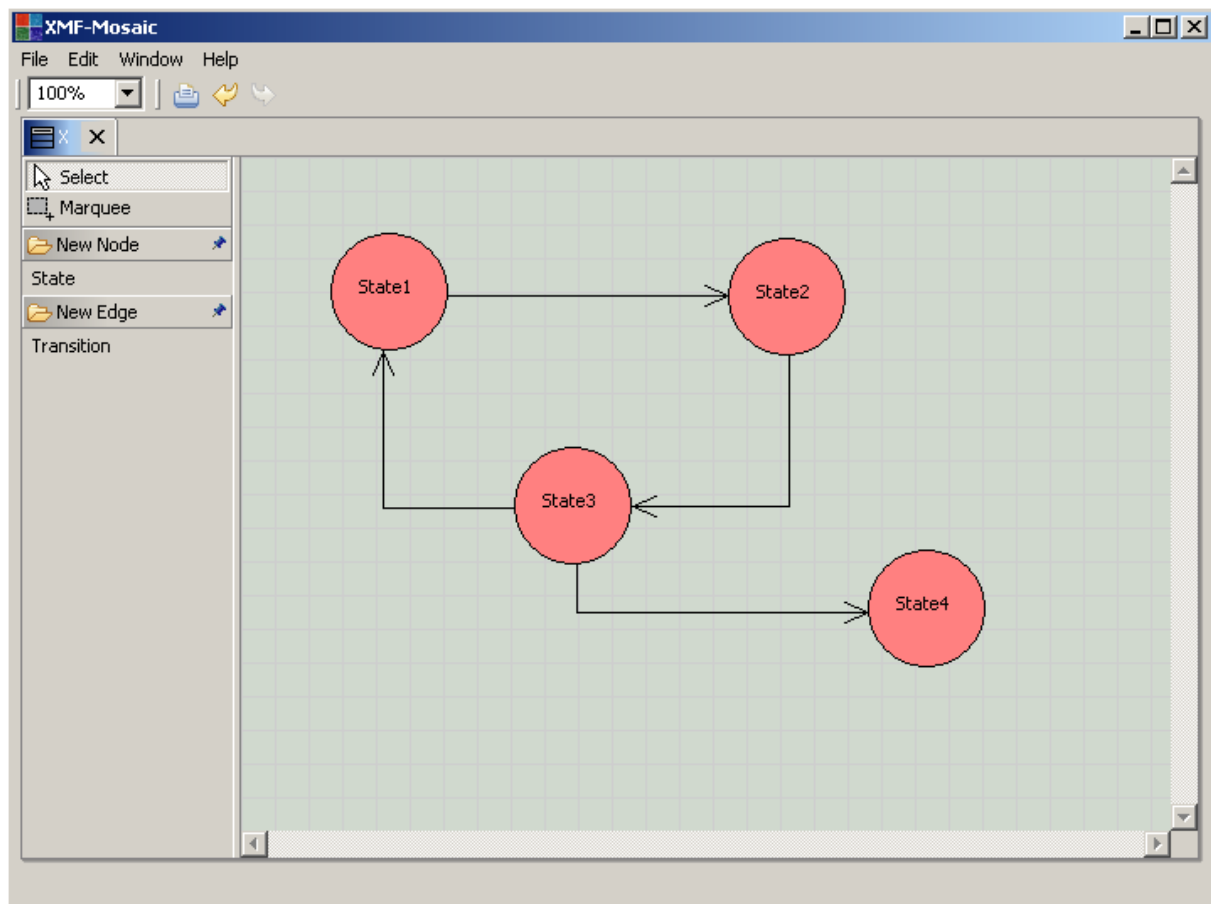

Figure 5.6:

be used to succinctly define the types of synchronisations between abstract and concrete syntax discussed in this chapter.

CHAPTER 6

SEMANTICS

6.1 Introduction

The purpose of this chapter is to describe how the semantics of modelling and programming languages can be described using metamodels. The semantics of a modelling language describes what the language means in terms of its behaviour, static properties or translation to another a language. The chapter begins by motivating the need for semantics and then describes a number of different approaches to defining semantics using metamodels. These approaches aim to provide a way of constructing platform independent models of semantics - thus enabling the semantics of a language to be interchanged between metamodelling tools. An example of how the approaches can be used to define the semantics of the StateMachine language is then presented.

6.2 What is Semantics?

In general terms, a language semantics describes the *meaning* of concepts in a language. When using a language, we need to assign a meaning to the concepts in the language if we are to understand how to use it. For example, in the context of a modelling language, our understanding of the meaning of a StateMachine or the meaning of a Class will form a key part of how we choose to use them to model a specific aspect of a problem domain.

There are many ways of describing meaning of a language concept. Consider the ways in which the meaning of concepts in natural languages can be described:

- In terms of concepts which already have a well defined meaning. For instance "a car consists of a chassis, four wheels, an engine, body, and so on". This is only meaningful if the concepts themselves are well defined.

- By describing the properties and behaviour of the concept: "a car can be stationary, or can be moving, and pressing the accelerator increases its speed".
- As a specialisation of another concept. For instance, "a truck is a vehicle with a trailer".
- By describing the commonly shared properties of all possible instances of a concept. For example, the concept of a car could be described in terms of the valid properties that every instance of a car should have.

In a natural language, semantics is a correlation or mapping between concepts in a language with thoughts and experiences of concepts in world around us. Although a more formal approach to semantics is required for modelling and programming languages, there is a close parallel to the approaches used to express natural language semantics described above. In both cases, a key requirement of a semantics is that it should be of practical use in understanding the meaning of a language.

6.3 Why Semantics?

A semantics is essential to communicate the meaning of models or programs to stakeholders in the development process. Semantics have a central role to play in defining the semantically rich language capabilities such as execution, analysis and transformation that are required to support Language-Driven Development. For example, a language that supports behaviour, such as a StateMachine, requires a semantics in order to describe how models or programs written in the language execute.

Traditionally, the semantics of many modelling languages are described in an informal manner, either through natural language descriptions or examples. For instance, much of the UML 1.X specification [uml01] makes use of natural language descriptions of semantics.

However, an informal semantics brings with it some significant problems:

- Because users have to assign an informal or intuitive meaning to models, there is significant risk of misinterpretation and therefore misuse by the users of the modelling language.
- An informal semantics cannot be interpreted or understood by tools. Tool builders are thus required to implement their own interpretation of the semantics. Unfortunately, this means that the same language is likely to be implemented in different ways. Thus, two different tools may offer contradictory implementations of the same semantics, e.g. the same StateMachine may execute differently depending on the tool being used!
- An informal semantics makes the task of defining new languages difficult. It makes it hard to identify areas where concepts in the languages are semantically

equivalent or where there are contradictions. It is harder still to extend an existing language if the semantics of the language are not defined.

- Standards require precise semantics. Without them, a standard is open to misunderstanding and misuse by practitioners and tool developers while significantly limiting interoperability.

6.4 Semantics and Metamodels

While it is clear that semantics is crucial part of a language definition, the question is how should semantics be described? One approach is to express semantics in terms of a formal, mathematical language. Many academic papers have been written describing the semantics of modelling languages in this way. Yet, the complex mathematical descriptions that result are hard to understand and are of limited practical use. Another approach is to express semantics in terms of an external programming language. This is a far more practical solution. Nevertheless, it results in a definition which is tied to a specific programming language thus compromising its platform independence. Furthermore, being forced to step out of the metamodeling environment into a programming language makes for a very non-intuitive language definition process.

An alternative strategy is to describe the semantics of languages using metamodels. There are some significant benefits to this approach. Firstly, the semantics of a language is fully integrated in the language's definition, which means the task of relating it to other language design artifacts (concrete syntax, mappings, abstract syntax, etc) is immediately simplified. Secondly, because the same metamodeling language is used across all languages, semantic definitions become reusable assets that can be integrated and extended with relative ease. Finally, and most crucially, semantics definitions are platform independent - they can be interchanged in the same way, and if they are understood by the tool that imports them, they can be used to drive the way that the tool interacts with the language. For instance, a semantics that describes how a StateMachine executes can be used to drive simulators across a suite of compliant tools. The ability to define semantics in a platform independent way is crucial to the success of Language-Driven Development. It enables tools to be constructed for languages that are both portable and interoperable irrespective of the environment in which they are defined.

It is important to note that a metamodel semantics is quite different from the abstract syntax model of a language, which defines the structure of the language. However, an abstract syntax model is a pre-requisite for defining a semantics, as a semantics adds a layer of meaning to the concepts defined in the abstract syntax. Semantics in this sense should also be distinguished from static semantics, which are the rules which dictate whether or not an expression of the language is well-formed. Static semantics rules are those employed by tools such as type checkers.

6.5 Approaches

There are many different approaches to describing the semantics of languages in a meta-model. This section examines some key approaches and gives examples of their application. All the approaches are motivated by approaches to defining semantics that have widely been applied in programming language domains. The main difference is that metamodels are used to express the semantic definitions.

The approaches include:

Translational Translating from concepts in one language into concepts in another language that have a precise semantics.

Operational Modelling the operational behaviour of language concepts.

Extensional Extending the semantics of existing language concepts.

Denotational Modelling the mapping to semantic domain concepts.

Each approach has its own advantages and disadvantages. In practice, a combination of approaches is typically used, based on the nature of individual concepts in the language. In each case, it is important to note that the semantics are described in the metamodelling language - no external formal representation is used. The following sections describe each of the approaches, along with a small example of their application.

6.6 Translational Semantics

Translational semantics is based on two notions:

- The semantics of a language is defined when the language is translated into another form, called the target language.
- The target language can be defined by a small number of primitive constructs that have a well defined semantics.

The intention of the translational approach is to define the meaning of a language in terms of primitive concepts that have their own well defined semantics. Typically, these primitive concepts will have an operational semantics (see later).

The advantage of the translational approach is that provided there is a machine that can execute the target language, it is possible to directly obtain an executable semantics for the language via the translation. This approach is closely related to the role played by a compiler in implementing a richer programming language in terms of more primitive executable primitives.

The main disadvantage of the approach is that information is lost during the transformation process. While the end result is a collection of primitives, it will not be

obvious how they are related to the original modelling language concepts. There are ways to avoid this, for instance information about the original language concepts can be "tagged" onto the target language, thus enabling it to retain information about the structure of the original language. Alternatively, one may consider maintaining information about the mapping between the two models.

The translational approach can be incorporated in a language definition in many different ways:

- Within a language metamodel by translating one concept into a concept that has a semantics, e.g. translating a case statement into a sequence of if statements, where the if statements have an operational semantics. Another example might be translating a rich mapping language into a collection of primitive mapping functions with additional information tagged onto the primitives to indicate the structure of the source language.
- Between language metamodels, by translating one metamodel into another. For example, an abstract syntax metamodel for UML can be mapped to a metamodel of a small well-defined language such as XCore, or to a programming language such as Java.

6.6.1 Approaches

There are a number of different approaches to implementing a transformational semantics in XMF:

- A mapping can be defined between the abstract syntax of the source and target languages. This could be written in a mapping language (such as XMap), or implemented by appropriate operations on the source model.
- The result of parsing the concrete syntax of the source language can be used to directly create an instance of the target language.
- The result of parsing the concrete syntax can be translated directly into machine code that can be run on the XMF virtual machine.

In the second approach, the intermediate step of generating an abstract syntax model for the source language can be omitted. The concrete syntax of the source language thus acts as *sugar* for the target language. This approach is particularly useful when constructing new types of expressions that can be desugared into a number of more primitive concepts, e.g. translating a case statement into a collection of if expressions.

The third approach requires the construction of machine code statements but has the advantage of resulting in a highly efficient implementation.

6.6.2 Example

Because XMF provides a number of well defined primitives, it is a good target for translation. As an example, consider defining a semantics for StateMachines via a translation from the StateMachine abstract syntax model (described in chapter 4). The mapping language used in this example is described in detail in chapter 8. A summary of the approach taken is shown in figure 6.1.

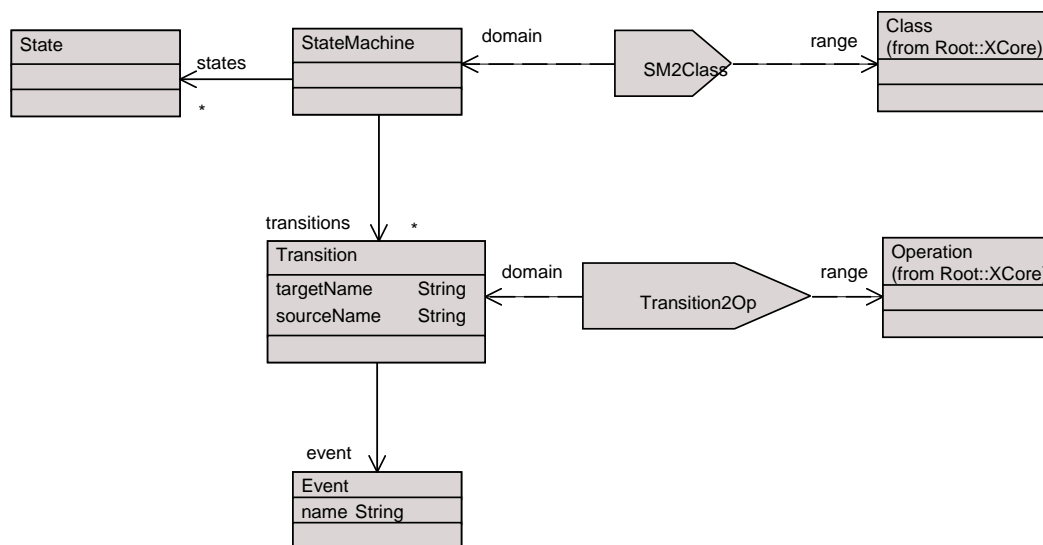

Figure 6.1: Overview of the translational mapping example

The aim is to translate a StateMachine into an instance of a XCore Class such that semantics of the StateMachine is preserved. This is achieved by ensuring that the Class simulates the behaviour of the StateMachine:

- The StateMachine is translated into a Class containing an attribute called *state*, whose permitted values are the enumerated state names of the StateMachine.
- The Class will inherit all the attributes and operations of the StateMachine's context class.
- Each transition of the StateMachine is translated into an operation of the Class with the same name as the transition's event.
- The transition will contain code that will simulate the invocation of the transition's guard and actions, causing the value of *state* to change.

The following pattern of code will thus be required in the body of each operation:

```

if <guard> then
  self.state := <target-state-name>;
  <action>
end

```

Where <guard> and <action> are the bodies of the corresponding transition's guard and action, and <target-state-name> is the name of the state that is the target of the transition.

The most challenging part of this translation is creating the appropriate code bodies in each operation. The following code shows how XOCL can be used to define an operation, `transitionOp()`, which given the guard, action, event name and target name of a transition, returns an XCore operation that simulates the transition. This operation is called by the `transition2Op` mapping. Note that in the operation `transitionOp()` an operation cannot be assigned a name until it is declared, thus `setName()` is used to assign it a name after it has been declared.

```

@Map Transition2Op
@Operation
transitionOp(g:Operation, a:Operation, eventName, targetName)
  let op = @Operation()
    if g() then
      a();
      self.state := targetName
    end
  end
in
  op.setName(eventName);
  op
end
end

@Clause Transition2Op
Transition
  [event = Set{
    Event
      [name = N]
  },
  name = T,
  guard = G,
  action = A]
do
  self.transitionOp(G, A, N, T.name)
end

```

end

This definition of `transitionOp()` makes use of the fact that in XMF an Operation is also an Object and can therefore be assigned to a variable.

As an example, consider the simple traffic light model shown in figure 6.2. The result of applying the `Transition2Op` mapping to the `GreenRed()` transition will be the following XOCL operation:

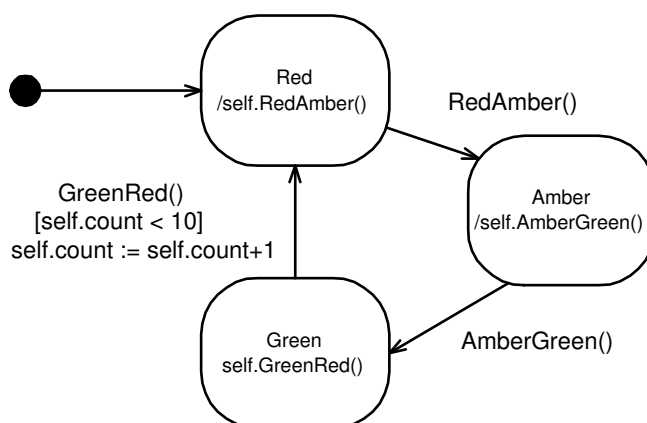

Figure 6.2: The traffic light example

```

@Operation GreenRed()
  if g() then
    a();
    self.state := "Red"
  end
end
  
```

where `g` and `a` are the following anonymous operation definitions:

```

@Operation anonymous()
  self.count < 10
end

@Operation anonymous()
  self.count := self.count + 1
end
  
```

6.7 Operational Semantics

An operational semantics describes how models or programs written in a language can be directly executed. This involves constructing an interpreter. For example, an assignment statement $V := E$ can be described by an interpreter that executes the steps that it performs: Evaluate the expression E and then change the value bound to the variable V to be the result.

The advantage of an operational semantics is that it is expressed in terms of operations on the language itself. In contrast, a translational semantics is defined in terms of another, possibly very different, language. As a result, an operational semantics can be easier to understand and write.

Writing an interpreter as part of a metamodel relies on the metamodeling language itself being executable. Provided this is the case, concepts can define operations that capture their operational behaviour.

Typically, the definition of an interpreter for a language follows a pattern in which concepts are associated with an operational description as follows:

- Operations will be defined on concepts that implement their operational semantics e.g. an action may have an `run()` operation that causes a state change, while an expression may have an `eval()` operation that will evaluate the expression.
- The operations typically take an environment as a parameter: a collection of variable bindings which will be used in the evaluation of the concepts behaviour, and a target object, which will be the object that is changed as a result of the action or which represents the context of the evaluation.
- The operations will return the result of the evaluation (a boolean in the case of a static expression) or change the value of the target object (in the case of an action).

6.7.1 Example

A `StateMachine` can be given an operational semantics by defining an interpreter that executes a `StateMachine`. It is implemented by constructing a `run()` operation for the `StateMachine` class. We also add an attribute `messages`, which records the messages that are pending on the `StateMachine` as a result of a `send` action on a transition:

The code that executes the `run()` operation is below. More details about the executable language used here, and the use of executability as a means of defining semantics, will be explained in chapter 7.

```
@Operation run(element)
    let state = self.startingState() in
    @While state <> null do
        let result = state.activate(element) then
```

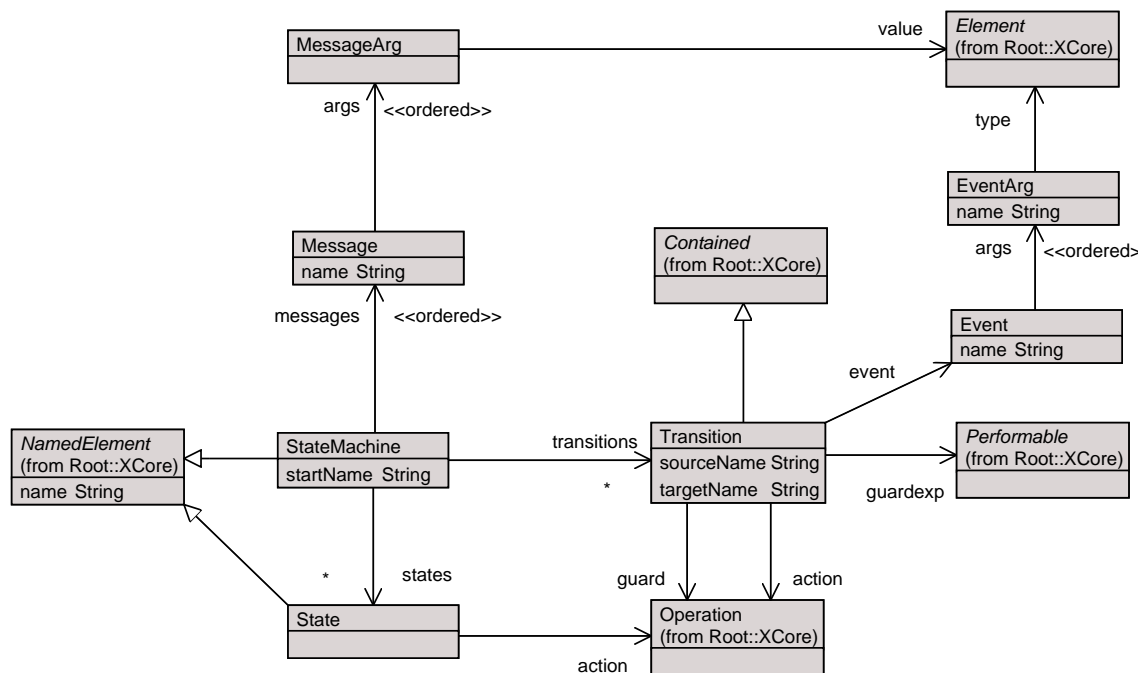

Figure 6.3: StateMachine model extended with message queues

```

transitions = self.transitionsFrom(state) then
enabledTransitions = transitions->select(t |
t.isEnabled(element,result) and
if t.event <> null then
    messages->head().name = t.event.name
else
    true
end) in
    if enabledTransitions->isEmpty then
        state := null
    else
        let transition = enabledTransitions->sel in
            transition.activate(element,result + self.messages->
                head().args.value);
            state := transition.target();
            if transition.event <> null then
                self.messages := self.messages->tail()
            end
        end
    end
end
end
end
end

```

```
    end
end
```

The operation takes the element that the StateMachine is being applied to. It first sets the state to be the starting state, then enters a while loop. Provided that the StateMachine has not terminated (state <> null) the following is performed:

1. The entry action on the current state is invoked by calling its activate operation.
2. The collection of enabled transitions is determined by selecting all the transitions that leave the current state such that the evaluation of their guard is true, and that an event is waiting on the machine that corresponds to the event on the transition.
3. If there are no enabled transitions, the state is set to null, and the run() operation terminates.
4. If there are enabled transitions, one of them is chosen and its action is invoked, before assigning the state to be the target of the transition.

Consider the traffic light example shown in figure 6.2. If the current state of the StateMachine is Green, then the above semantics ensures that the guard on the GreenRed() transition will be evaluated and if it returns true the action on transition will be executed.

As this example shows, complex behaviour can be captured in terms of operational definitions. Moreover, the definition can immediately be tested and used within a tool to provide semantically rich means of validating and exercising models and programs written in the language.

6.8 Extensional Semantics

In the extensional approach, the semantics of a language is defined as an extension to another language. Modelling concepts in the new language inherit their semantics from concepts in the other language. In addition, they may also extend the semantics, adding new capabilities for example.

The benefit of the approach is that complex semantic concepts can be reused with minimum effort. For example, a business entity need not define what it means to create new instances, but can inherit the capability from Class.

The extensional approach has some commonality with the notion of a profile ([uml01]). A profile provides a collection of stereotypes, which can be viewed as sub-classes of UML or MOF model elements. However, by performing the extension at the meta-model level, greater expressibility is provided to the user, who can add arbitrarily rich semantic extensions to the new concept. A suitable tool can make use of this information to permit the rapid implementation of new modelling languages. It may recognise

that an extension has occurred, and use stereotype symbols to tailor the symbols of the original modelling language to support the new language (see section 9.2.2).

6.8.1 Example

As an example, consider the requirement to be able to create multiple instances of the same StateMachine. This can be achieved by specialising the class Class from the XCore metamodel (see figure 6.4). Because Class is instantiable, the StateMachine will also inherit its semantics.

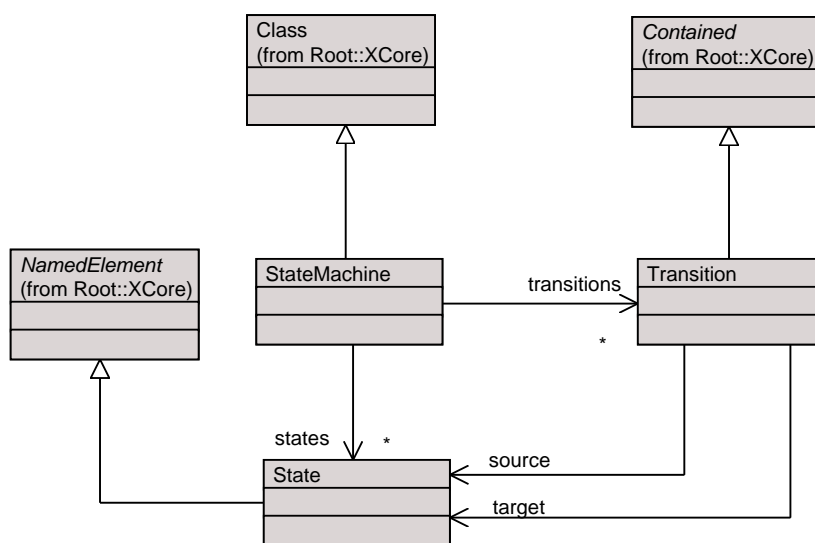

Figure 6.4: Example of extending the class Class

By specialising the class NamedElement a State can be owned by a StateMachine and can be navigated to via a pathname. Similarly, a Transition can be owned by a StateMachine, but in this case it cannot have a name as it specialises the class Contained.

While the extensional approach is appealing in terms of its simplicity, it does have its disadvantages. Firstly, it is tempting to try and 'shoe-horn' the complete semantics of a language into this form. In practice this is usually not possible as there will be concepts that simply do not fit. In these cases, other approaches to defining semantics must be used.

6.9 Denotational Semantics

The purpose of denotational semantics is to associate mathematical objects, such as numbers, tuples, or functions, with each concept of the language. The concept is/are said to *denote* the mathematical object(s), and the object is called the *denotation* of the

concept. The objects associated with the concept are said to be the *semantic domain* of the concept. A widely used example of this in programming language semantics is the denotation of the operation $+$ by a number. For instance, the denotation of $4+5$ is 9.

A denotational semantics can be thought of as semantics by example. By providing all possible examples of a concept's meaning, it is possible to define precisely what it means. In the above example, there is only one denotation. However, many concepts are denoted by a collection of examples. To describe the semantics of an Integer, the set of all positive numbers would be required, i.e. the denotation of Integer is $0..infinity$. Denotational descriptions of semantics tend to be static, i.e. they enumerate valid instances of a concepts, and a non-executable fashion.

Here are some common examples of denotational relationships found in metamodels:

- The denotation of a Class is the collection of all Objects that may be an instance of it.
- The denotation of an Action is a collection of all possible state changes that can result from its invocation.
- The denotation of an Expression is the collection of all possible results that can be obtained from evaluating the expression.

A denotational semantics can be defined in a metamodel by constructing a model of the language's abstract syntax and semantic domain and of the semantic mapping that relates them. Constraints are then written that describe when instances of semantic domain concepts are valid with respect to their abstract syntax. For example, constraints can be written that state when an Object is a valid instance of a Class.

The advantage of the denotational approach is its declarative nature. In particular, it captures semantics in a way that does not commit to a specific choice of operational semantics. For instance, while an operational semantics would have to describe how an expression is evaluated, a denotational semantics simply describes what the valid evaluation/s of the expression would be.

In practice a purely denotational approach is best used when a high-level specification of semantics is required. It is particularly useful in a standard where commitment to a specific implementation is to be avoided. Because they provide a specification of semantics they can be used to test implementations of the standard: candidate instances generated by an implementation can be checked against the denotational constraints. A good example of the denotational semantics approach is the OCL 2.0 specification [ocl04], where they are used to describe the semantics of OCL expressions.

6.9.1 Example

We can describe the execution semantics of a StateMachine by modelling the semantic domain concepts that give it a meaning. A useful way of identifying these concepts is to consider the vocabulary of concepts we would use to describe the behaviour of a

StateMachine. This might include concepts such as a state change (caused by a transition), examples of statemachines in specific states, and message queues.

Figure 6.5 shows an example of a semantic domain that might result from generalising these concepts into a model.

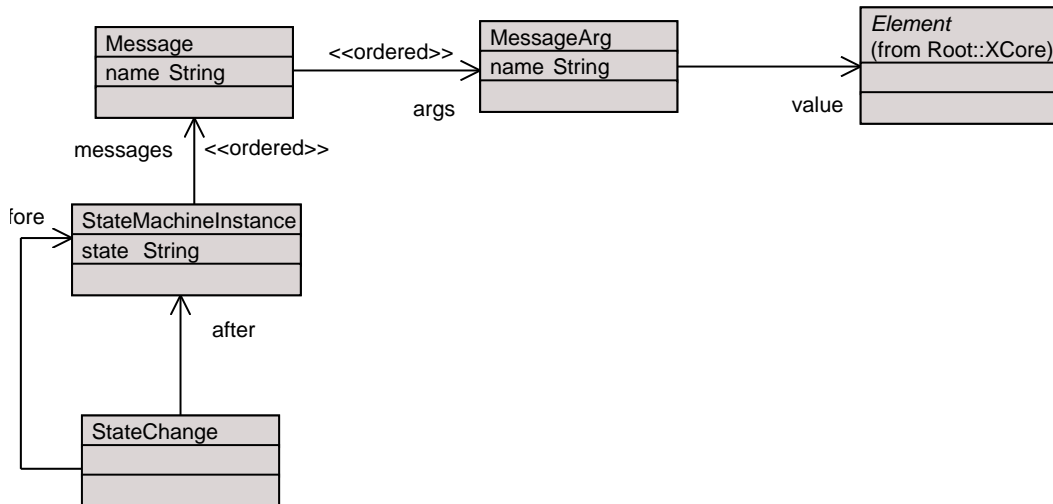

Figure 6.5: A semantic domain for StateMachines

The denotation of a StateMachine is essentially a model of the valid state changes that may occur to the StateMachine at any point in time. Here a StateMachineInstance is used to model a StateMachine at a specific point in time. It has a state, and a sequence of messages which are waiting to be consumed by the machine. State changes represent the invocation of a transition, causing the StateMachine to move from one state (the before state) to another (the after state).

Using this model, many different examples of valid StateMachine behaviours can be tested. The snapshot in figure 6.6 shows a fragment of the behaviour of a machine that has two transitions from the state A to the state B and back again.

In order to complete the model, the relationship between the semantic domain and abstract syntax model must also be modelled. This relationship, commonly called a *semantic mapping*, is crucial to defining the semantics of the language. It makes precise the rules that say when instances of semantic domain concepts are valid with respect to an abstract syntax model. In this case, when a particular sequence of state changes is valid with respect to a specific StateMachine.

Figure 6.7 shows the semantic mapping model. A StateMachineInstance is associated with its StateMachine, while a StateChange and Message are associated with the Transition and Event that they are instances of.

Finally, well-formedness rules will be required. An example is the rule which guarantees that the before and after states of a StateChange commutes with the source and target states of the transition it is an instance of:

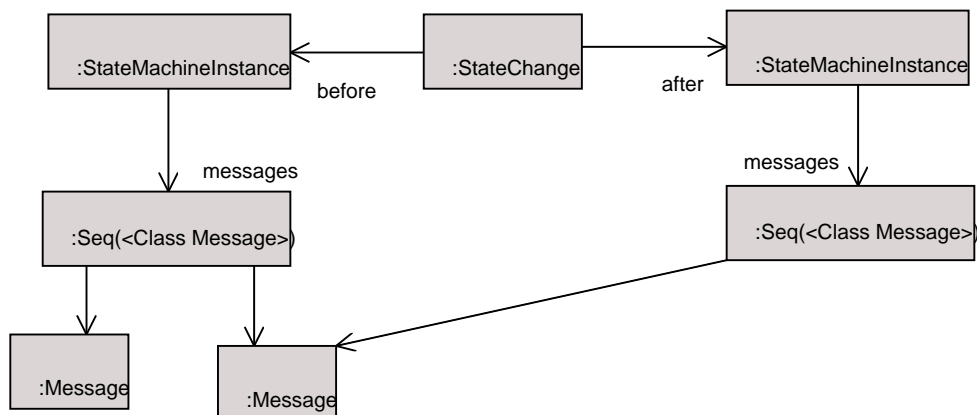

Figure 6.6: An example snapshot of a StateMachine's behaviour

context StateChange

```
self.transition.sourceName = self.before.state.name and
self.transition.targetName = self.after.state.name
```

Other rules will be required to ensure that the state changes associated with a state machine are valid with respect to its execution semantics. These will describe such aspects as the conditions under which transitions are enabled, and the order in which they may fire.

6.10 Process

The choice of semantics depends on the type of language being defined. The following pointers provide a guide to choosing the most appropriate approach.

- If a declarative, non executable semantics is required, use the denotational approach.
- If a language has concepts that need to be evaluated, executed or instantiated then they should be modelled using an operational, translational or extensional approach. The choice of approach will be based on the following:
 - If a concept is clearly a sugared form of more primitive concepts, adopt a translation approach. This avoids having to construct a semantics for the concept from scratch - reuse the semantic machinery that has already been defined for the primitive concepts. This approach should only be used when it is acceptable to loose information about the original concept.

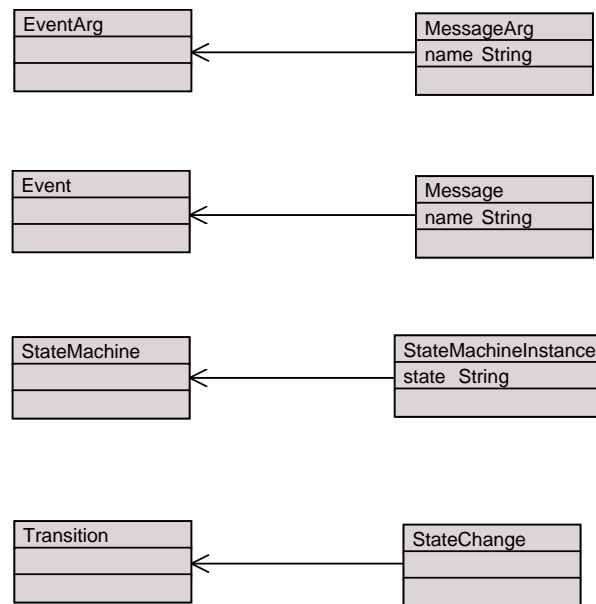

Figure 6.7: Semantic mapping model for the StateMachine language

- If information must be kept about the concept and it is possible to reuse an existing concept use the extensional approach.
- If there is no convenient means of reusing an existing concept use the operational approach to construct an interpreter.

Note, there are no hard and fast rules to choosing an approach. The primary aim should be to develop a semantic model that meets the needs of the stakeholders of the language.

6.11 Conclusion

Semantics is crucial in being able to understand the meaning of a modelling language, to be able to interact with it a meaningful way, and to be able to support truly interoperable language definitions. This chapter has shown that a language semantics can be successfully captured with a metamodel. The key advantages are that the semantics becomes an integrated part of the language definition while remaining understandable to users and modelling tools.

CHAPTER 7

EXECUTABLE METAMODELLING

7.1 Introduction

The purpose of this chapter is to describe how the addition of executable primitives to a metamodeling language can result in a powerful meta-programming environment in which many different operational aspects of languages can be described. This includes the ability to model the operational behaviour of a modelling or programming language and the ability to quickly create many types of applications to manipulate models.

7.2 Why Executable Metamodeling?

Executable metamodeling is a natural evolution of a growing trend towards executable modelling [Mel02]. Executable modelling enables the operational behaviour of system models to be captured in a form that is independent of how the model is implemented. This is achieved by augmenting the modelling language with an action language or other executable formalism. Executable models enable a system to be tested before implementation begins, resulting in improved validation of the system design. Furthermore, it is also possible to generate executable code from an executable model, as there is sufficient information to generate method bodies, etc, in the target programming language.

The ability to execute *metamodels* has additional benefits over and above those associated with executable modelling. At the simplest level, many developers need the facility to access and manipulate models at the metamodel level. For instance, a developer may need to analyse general properties of their models, or to globally modify certain features of a model, or write useful functions that automate a time consuming modelling task. Being able to quickly add some functionality that will perform the required task will thus save time and improve the modelling process.

More generally, the addition of executability to metamodels facilitates what is almost metamodeling nirvana: the ability to model all aspects of a modelling language as a unified, executable entity. A static metamodel cannot model the operational behaviour of a language. Yet, in the semantic rich tools that are required by Language-Driven Development, capturing this aspect of a language is essential. With an executable metamodeling language, all of this can be described in the metamodel itself.

The advantage is that the modelling language definition becomes completely self contained, and can be interchanged between any modelling tool that supports the necessary metamodeling machinery. Such definitions are not reliant on platform specific technology but the metamodel architecture that they are defined within (which as we shall see can itself be modelled independently of other technologies).

7.2.1 Executability and XMF

Because XMF is also defined in terms of an executable metamodel, XMF can effectively implement everything associated with supporting itself as a language definition language, including the construction of parsers, compilers, interpreters and so on. The key advantage is that there is unification in the way that all modelling languages are constructed. Thus, a language for modelling StateMachines will use entirely the same meta-machinery as a language for modelling user interactions, business use cases, and so on. Moreover, because the definition is in effect a program, it will be as precise and unambiguous as any program written in a programming language. Of course, it is still necessary that the machinery developed to support XMF is as generic as possible to facilitate the rapid construction of new modelling languages - being executable does not necessarily mean that it is generic.

A unified executable metamodeling environment offers important advantages to the language developer. We have seen many metamodeling tools where the developer has to contend with a multitude of ill-fitting languages for dealing with each of the different aspects required for tool design. For instance, a repository for dealing with meta-data, a scripting language for model manipulation, a GUI framework for user interface design, and `lex` and `yacc` for parser construction. An approach in which all these languages are unified under a single executable metamodeling umbrella offers a far more effective and productive development environment.

Executable metamodeling is at the heart of the tool development vision described in chapter 2. By supporting executability, metamodels are enriched to the point where they can support a multitude of semantically rich tool capabilities.

7.2.2 Executable Metamodeling and Programming

How does executable metamodeling relate to programming? Not at all? In fact it is a natural extension (see section 2.3). Rather than thinking about modelling languages as being different to programming languages, executable metamodeling really views

modelling languages as part of a spectrum of programming languages, where each language is only different in the abstractions and behaviour it encapsulates. Indeed, executable metamodelling can be thought of as next generation programming: whilst many programming languages are fixed in what they can represent, executable metamodelling offers infinite extensibility and flexibility.

7.3 Adding Executability

How can executability be added to a metamodelling language? The answer (briefly discussed in chapter 3) is to provide the action primitives necessary to support execution. These in combination with a suitable model querying and navigation language, result in a powerful metaprogramming language.

The language proposed here is XOCL (eXecutable OCL). XOCL is a combination of executable primitives and OCL (the Object Constraint Language). The motivations for this combination are discussed in section 3.5.

The action primitives that are provided by XOCL are as follows:

Slot Update Assigns a value to a slot of an object via the assignment expression `:=`. An example of slot update might be `self.x := self.x + 1`.

Object Creation Creates a new instance of a class via a new operation on a class from which the object is created. An example might be: `fido := Dog()`.

Sequential Operator Enables two expressions to be executed in sequence via the operator `;`. For instance, `self.x:=self.x+1; self.x:=self.x+2` will result in `x` being incremented by 3.

XOCL expressions can be used in the bodies of expressions belonging to behavioural modelling elements such as operations and mappings. The following operation is described in the context of the class `X`:

```

context X
  @Operation doIt():Integer
    self.x := self.x + 1;
    self.x
  end

```

The above primitives provide the minimal actions necessary to add sequential executability to OCL. Concurrent execution can be supported by adding a suitable concurrency primitive such as `fork()`, which allows multiple threads of execution to be propagated. While the majority of metamodels only require sequential execution, there are some cases where concurrency needs to be supported. Examples include providing

models of communication between clients and a server or in describing the operational semantics of concurrent modelling languages.

Finally, it is important that XMF provides the necessary architecture to support execution in an object-oriented environment. This aspect, called a Meta-Object Protocol or MOP will be discussed in later versions of this book.

7.3.1 XOCL Extensions

While OCL provides a number of useful imperative style constructs, such as *if* and *for* loop expressions, there are a small number of extensions that we have found to be very useful when using it as a programming language. These include:

While expressions: standard while loops as provided by many programming languages:

```
@While x < 10
  do x := x + 1
end
```

Find expressions: a simplified way of traversing collections of models and finding an element that matches specific criteria. If xset contains an x whose value is greater than zero, y will be incremented by 1.

```
@Find (x, set)
  when x > 10
  do
    y := y + 1
  end
```

Tables provide efficient lookup over large data structures:

```
let table = Table() in
  table.put(key, value);
  table.get(key)
end
```

The case statement as provided by many programming languages:

```
@Case(x)
  x > 1 do x := x + 1;
  x = 0 do x := 2
```

end

TypeCase expressions: selects a case statement depending on the type of object that is passed to it.

```
@Case(x)
  Boolean do x := false;
  Integer do x := 0
end
```

Because objects are fundamental to XMF, a number of operations are provided for accessing and manipulating their properties:

- The operation `of()` returns the class that the object is an instance of, e.g. `StateMachines::State.of()` returns `XCore::Class`.
- The operation `getStructuralFeatureNames()` returns the names of the slots (attribute values) belonging to an object, e.g. if `x` is an instance of the class `StateMachines::State`, then `x.getStructuralFeatureNames()` will return the set containing "name".
- The operation `get()` takes a name and return the value of the slot of that name, e.g. `x.get("y")` will return the value of the slot called "y".
- The operation `set()` take a name and a value, and sets the value of the slot called name to be the value, e.g. `x.set("y",10)`, will set the value of the slot called "y" to 10.

7.4 Examples

The best way to understand the benefits of executable metamodeling is to look at some real examples. This section provides a number of examples that provide general utility operations for manipulating metamodels. Other parts of the book (notably chapter 6) describe how executability can be used to define semantics. The case study chapters at the end the book also provide examples of executable metamodels.

7.4.1 Example 1: Model Merge

Merging the contents of two packages is a very useful capability that has many applications, including versioning (merging different versions of a model together) and model management (breaking up large models into composable pieces that can be merged into a single artefact). The following operation is defined on a package.

```

context Package
  @Operation merge(p:Package)
    self.contents()->collect(c1 |
      if p.contents()->exists(c2 | c1.isMergable(c2)) then
        c1.merge(c2)
      else
        c1
      end)->union(
      p.contents()->select(c2 | self.contents()->exists(c1 |
        not c1.isMergable(c2))))
  end

```

The operation merges an element belonging to the package *p* with an element belonging to the contents of the package provided they are mergeable. Note `contents()` is a meta-operation belonging to all containers (see section 9.5). The conditions under which two elements are mergeable will be defined on a case by case basis. For example, two elements may be mergeable if they have the same name and are of the same type. If two elements are mergeable, then the result of the merge will be defined via a `merge()` operation on the elements' types.

7.4.2 Example 2: Find and Replace

This example defines a simple algorithm for finding and replacing named elements in the contents of a `Namespace`. It works by determining whether an object is a specialisation of the class `NamedElement`, and then performs the appropriate substitution if the element name matches a name in the to be replaced in the `subs` list:

```

context Namespace
  @Operation replace(subs:Set(Sub))
    @For i in self.contents
      if i.isKindOf(NamedElement) then
        if subs->exists(r | r.from = i.name) then
          i.name := subs->select(s | r.from = i.name)->sel.to
        end
      end
    end
  end

```

Where the class `Sub` is defined as follows:

```

@Class Sub
  @Attribute from : String end

```

```
@Attribute to : String end
end
```

Applying this operation to any Namespace is now straightforward. For instance, the operation `replaceStateName()` can be written like so:

```
context StateMachine
  @Operation replaceStateName(subs:Set(Sub))
    self.replace(subs);
    self
  end
end
```

This operation is a useful mechanism for performing global search and replace on models and programs.

7.4.3 Example 3: Walker

The previous example is restricted as it only applies to Namespaces. In many situations, one wants to be able to walk over any structure of objects in a metamodel performing arbitrary tasks. These tasks may include find and replace, but could be anything from constraint checking to the global invocation of operations.

This can be achieved using a walker. A walker recursively descends into an elements structure and dispatches to appropriate operations depending on the values of component elements. A critical requirements is that the walker can handle cycles in a structure. It does this by recording the elements that have been walked, and then using this information to ignore those elements if they are met again.

```
@Class Walker
  @Attribute table : Table end
  @Attribute refCount : Integer end
  @Attribute visited : Integer (?) end

  @Constructor()
    self.initWalker()
  end

  @Operation initWalker()
    self.table := Table(1000)
  end
end
```

The class Walker contains a hashkey table, in which a list of all the walked elements is kept along with an integer reference to the element. A count is kept of the number of elements that have been walked along with the number of references created.

```

context Walker
  @Operation encounter(e:Element)
    self.encounter(e, self.newRef())
  end

  @Operation encounter(e:Element, v:Element)
    // Save a reference to v against the walked value e.
    table.put(e, v)
  end

  @Operation newRef():Integer
    self.refCount := refCount + 1;
    refCount
  end

```

The encounter() operation is called when a new element is encountered. It creates a new reference for the element, and adds it to the table.

The following operations deal with walking the tree. The operation encountered() returns true if the element has already been encountered.

```

context Walker
  @Operation encountered(e:Element):Boolean
    // Returns true when we have already walked e.
    table.containsKey(e)
  end

  @Operation getRef(e:Element):Element
    table.get(e)
  end

  @AbstractOp reWalk(e:Element, arg:Element):Element end

```

The operation walk() performs the task of walking an element. If the element has already been encountered then the operation reWalk() is run (this will be specialised for specific applications, but in most cases it will do nothing). Otherwise, depending on the type of element that is being walked, appropriate element walkers will be called.

```

context Walker

```

```

@Operation walk(e:Element, arg:Element):Element
  // Walk the element e with respect to the argument.
  self.visited := visited + 1;
  if self.encountered(e)
    then self.reWalk(e, arg)
  else
    @TypeCase(e)
      Boolean      do self.walkBoolean(e, arg) end
      Integer      do self.walkInteger(e, arg) end
      Null         do self.walkNull(arg) end
      Operation    do self.walkOperation(e, arg) end
      SeqOfElement do self.walkSeq(e, arg) end
      SetOfElement do self.walkSet(e, arg) end
      String       do self.walkString(e, arg) end
      Table        do self.walkTable(e, arg) end
      Object       do self.walkObject(e, arg) end
      else self.defaultWalk(e, arg)
    end
  end
end
end

```

The most complex of these walkers is the object walker. This gets all the structural feature names of the object, i.e. the names of the attributes of the class the object is an instance of. To do this, it uses the `getStructuralFeatureNames` operation defined on the class `Object` to return the names of the structural features. It then walks over each of the slots that correspond to each structural feature:

```

context Walker
  @Operation walkObject(o:Object, arg:Element):Element
    self.encounter(o);
    @For name in o.getStructuralFeatureNames() do
      self.walkSlot(o, name, arg)
    end
  end
end

```

Again, `walkSlot()` will be defined on an application basis, but in general will simply get the element value of each slot and call its walker.

This example illustrates the benefits of being able to program at the meta-level. It allows the designer to produce code that is reusable across multiple metamodels irrespective of what they define. It does not matter whether the object that is being walked is a `StateMachine` or a `BusinessEntity`. At the meta-level they are all viewed as objects.

7.4.4 Example 4: Meta-Patterns

This example shows how meta-operations can stamp out a structure over existing model elements. This can be used as the basis for capturing libraries of reusable patterns at the meta-level.

The following operation captures a simple containership pattern, which can be used to stamp out a containership association between two classes and adds an add() operation to the owning class.

Given a pair of classes, *c1* and *c2*, the operation first creates an instance of an attribute, *a*, whose name is the name of *c2*, and whose type is the class *c2*. Next, an anonymous operation is created called *c2*. It takes an object *x* and sets the value of the attribute name *c2* to the value of *x* including its existing contents. It's name is then set to "add" plus the name of *c2*. Finally, both the attribute and the operation are added to the class *c1*.

```

context Root
@Operation contains(c1 : Class,c2 : Class):Element
  let a = Attribute(Symbol(c2.name),Set(c2));
    o = @Operation anonymous(x : Element):Element
      self.set(c2.name,self.get(c2.name)->including(x))
    end
  in o.setName("add" + c2.name);
    c1.add(a);
    c1.add(o)
  end
end

```

Figures 7.1 and 7.2 show the result of applying the operation to two classes.

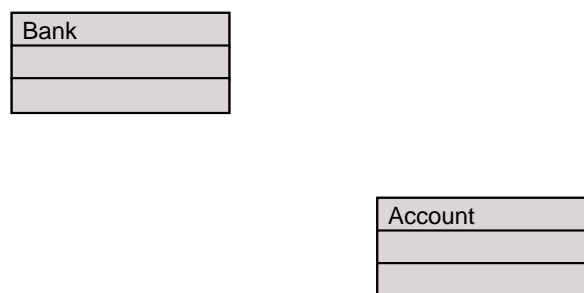

Figure 7.1: An example model before applying the contains operation

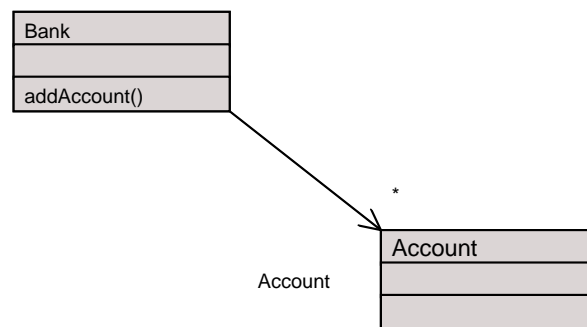

Figure 7.2: An example model after applying the contains operation

7.5 Conclusion

This chapter has aimed to show the benefits that can be achieved through the extension of traditionally static metamodeling languages to fully executable metamodeling. The resulting language can be used in the definition of useful meta-level utility operations right through to the construction of complete modelling language definitions. This has wide-reaching applications for how we treat metamodels. Rather than viewing them as static entities, they can now be viewed as highly abstract programming devices for language design.

CHAPTER 8

MAPPINGS

8.1 Introduction

A mapping is a relationship or transformation between models or programs written in the same or different languages. Mappings are a key part of the metamodelling process because of the important role they play in describing how instances of one metamodel are to be mapped to instances of other metamodels.

In the world of system development, mappings are everywhere: between abstract (platform independent) models and platform specific implementations, between legacy code and re-engineered systems, across and within application and organisational domains. Each of type of mappings places different requirements on the type of mapping language that is required. Sometimes, a one shot, unidirectional transformation is required. Other times, a mapping must maintain consistency between models, perhaps by continuously reconciling information about the state of both models. A mapping language has to be able to deal with all these requirements.

At the time of writing, work is already underway, initiated by the Object Management Group in the form of a request for proposals (RFP) [qvt02] to design a standard mapping language, provisionally entitled QVT (Queries, Views, Transformations). Even though there are many proposed meta-models for a mapping language there are some basic foundations which are fairly independent of the particular meta-model itself. This chapter begins with a discussion on applications and existing technologies and techniques for mappings and moves on to identify the requirements for an ideal mapping language. Two languages, XMap and XSync are then described that together address the complete requirements.

8.2 Applications Of Mappings

The application of mappings can be broadly divided into vertical, horizontal and variant dimensions of a problem domain [Boa01].

8.2.1 Vertical Mappings

Vertical mappings relate models and programs at different levels of abstraction. Examples include mapping between a specification and a design, and between a design and an implementation. In MDA the mapping from more abstract models to less abstract, more detailed models and programs is typically known as a PIM (platform independent model) to PSM (platform specific model) mapping. Note, these terms are somewhat relative (machine code can be viewed as platform specific in relation to Java, yet Java is often viewed as a platform specific in relation to UML).

The precise nature of a vertical PIM to PSM mapping will be dependent upon the nature of the target platform. For example, the following platform properties may be taken into account:

- **Optimisation:** improving one or more aspects of the efficiency of the resultant platform specific code, e.g. efficiency of memory usage, speed of execution, and usage of dynamic memory allocation.
- **Extensibility:** generating platform specific code that is more open to adaptation, e.g. through the use of polymorphic interfaces.
- **Language paradigm:** Removing (or adding) language features, for instance substituting single inheritance for multi-inheritance or removing inheritance altogether.
- **Architecture:** if the target platform is a messaging broker, such as CORBA, rules will be defined for realising the platform independent mapping in terms of appropriate interface calls to the message broker.
- **Trustworthiness:** visible and clear mappings may allow some level of reasoning to be applied to the target notation, which may enable certain properties (e.g. pertaining to safety) to be automatically established.

It is important to note that vertical mappings may also go in the reverse direction, e.g. from implementation to design. This is particularly appropriate for reverse engineering. Here the essence of the functionality of the platform specific language is reverse engineered into another language. Typically, this process will not be an automatic one, but must be supported by tools.

8.2.2 Horizontal Mappings

Whilst vertical mappings have received much attention in the MDA literature, horizontal mappings are just as important. Horizontal mappings describe relationships between different views of a problem domain. Examples of these include:

System Views

In large systems, many different aspects of the problem domain will need to be integrated. This may include different aspects of the business domain such as marketing or sales, or the technology domain such as safety or security. Critically, many of these different aspects will overlap. Horizontal mappings can be defined between languages that capture these different views, allowing them to be consistently managed.

Language Views

Complex systems can rarely be modelled using a single notation. As the popularity of UML has demonstrated, different notations are required to precisely and succinctly model different view points of the system. For instance, in UML, class diagrams are used to model the static structure of a system and a completely different language, state machines for example, to model the dynamic view point. Even though these notations are different they describe the same system with overlapping views and hence there exists a relationship between them.

As shown in chapter 5, horizontal mappings provide a means of integrating language notations in a way that ensures changes in one view automatically updates other views. Figure 8.1 shows how this might work for a small part of UML. Here, it is assumed that there is a core OO modelling language, with its own, precisely defined semantics. Many of the different modelling notations provided by UML are modelled as a view on the underlying OO modelling language. Mappings reconcile changes to the diagrams by making changes to the underlying OO model, which in turn may impact models in other diagrams.

Of course, previous chapters have shown that horizontal mappings are also necessary for integrating different aspects of a modelling language. Mappings between concrete syntax and abstract syntax, and between abstract syntax and a semantic domain are all critical parts of a language definition.

8.2.3 Variant Dimensions

Variant dimensions include product families and product configurations. Mappings can model the relationship between variant dimensions enabling each dimension to be precisely related to one another.

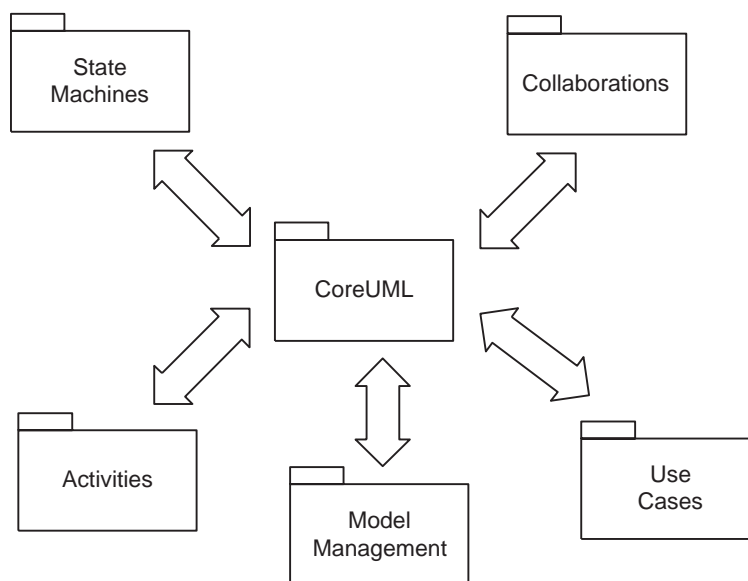

Figure 8.1: An example of a horizontal mapping between core UML and its diagrams

8.3 Types of Mappings

8.3.1 Unidirectional Mappings

Unidirectional mappings take an input model or collection of input models and generate an output model in one go. A unidirectional mapping may record information about the relationship between the input and output model, but there is no dependency of the input model on the output model. If the input model/s change, then the entire mapping must be rerun again in order to re-generate the output model.

An example of a one shot mapping is a code generator, that takes a platform independent model as its input, and generates a platform specific model or program.

8.3.2 Synchronised Mappings

Synchronised mappings are a special class of mapping where it is important to continuously manage consistent relationships between models. This requirement can occur in many different situations. One common example is maintaining consistency between a model and the code that it is being transformed to. This would be a requirement if a programmer wants to add/change code whilst maintaining consistency with the model it is generated from. In this scenario a change to the code would be immediately reflected back in the model, and vice versa: if the model was changed, it would be reflected in changes in the code. In the context of horizontal mappings, synchronised mappings have an important part to play in maintaining consistency between different

viewpoints on a model.

8.4 Requirements of a Mapping Language

When applying mappings on real projects it becomes apparent that there are some key requirements that a mapping language must support if it is to be of practical use. These include the following:

- Support for mappings of relatively high complexity. For example, the mapping language should be able to model complex mappings, such as transforming an object oriented model into a relational model including the mapping of the same attribute to different columns for foreign key membership [qvt02]. In practice, this means that the mapping language must provide good support for arbitrarily complex queries of models (to be able to access the information necessary to drive a complex mapping), and support the ability to modify models using relatively low level operations (such operations can, if used sensibly, significantly reduce the size and complexity of a mapping).
- Support for reuse. It should be possible to extend and adapt mappings with ease. This meets the need to be able to reuse existing mappings rather than having to create them from scratch each time.
- Facilitate the merging of models. If the source metamodel of a mapping represents a graph then any duplicate elements that are generated by the mapping must be merged.
- Provide mechanisms that support the structuring of mappings, e.g. being able to model the fact that a mapping owns or is dependent on sub-mappings.
- Be able to record information about a mapping to provide traceability during the mapping process.
- Integration within the metamodel architecture, so that mappings may access models at all levels.
- Support for execution. It may seem obvious, but a mapping should be executable in order to support the physical generation of new models from a mapping. This is contrasted with a non-executable mapping (see below).
- Provide diagrammatic notations that can be used to visualize mappings. Visual models have an important role to play in communicating the overall purpose of a mapping.
- Support for bi-directional and persistent mappings. As described above, this is essential in being able to support mappings where models must be synchronised with other models.

- Support for mapping specifications. A mapping specification is a non-executable description of 'what' a mapping does, which does not commit to 'how' the mapping will be implemented. Mapping specifications are a valuable means of validating the correctness of an executable mapping, or as a contract between a designer and an implementor.

An important question to ask at this point is whether all these requirements can be addressed by a single mapping language. In our experience, it does not make sense to have a 'one size fits all' mapping language because not all the requirements are complimentary. In particular, there is a strong distinction to be made between a bi-directional and unidirectional mapping languages. Each are likely to be targeted at different types of problems and thus have different requirements in terms of expressibility and efficiency.

Instead, it is better to use a small number of mapping languages, each targeted at a specific mapping capability, yet still capable of being combined within a single model. This is strategy taken in this book. In the following sections, two mapping languages, XMap and XSync are described each aimed at addressing complimentary mapping capabilities.

8.5 XMap

XMap is a language designed to support unidirectional mappings. It includes the following features:

Mappings Mappings are used to model unidirectional transformations from source to target values. Mappings have state and can be associated with other mappings.

Syntax Mappings have a visual syntax, enabling them to be drawn between model elements in a class diagram, and a concrete syntax for describing the detailed aspects of the mapping.

Executability Mappings have an operational semantics enabling them to be used to transform large models.

Patterns Mappings are described in terms of patterns. A pattern describes what a mapping does in terms of how a value in the source model is related to a value in the target model - this provides maximum declarative expressibility, whilst also remaining executable. Patterns are described in a pattern language that runs over OCL expressions.

OCL Mappings can make use of OCL to express complex model navigations.

In addition, XMap provides *Mapping specifications*. These are multi-directional, non-executable, transformation specifications. In the general case they are non-executable,

but useful restricted types of mapping specification can be automatically refined into mappings. Mapping specifications are written in a constraint language, in this case OCL. Typically they are used in the specification stages of system development.

The syntax and semantics of XMap are described in exactly the same way that all languages are defined in XMF: as an XMF metamodel, with an operational semantics expressed in terms of XOCL.

8.6 XMap Syntax

XMap has a visual syntax and a textual syntax. As shown in figure 8.2 the visual syntax consists of a mapping arrow that can be associated with other model elements such as classes in a class diagram. A mapping has a collection of domain or input elements that are associated with the tail of the arrow, and a single range or output element that is associated with the end of the arrow.

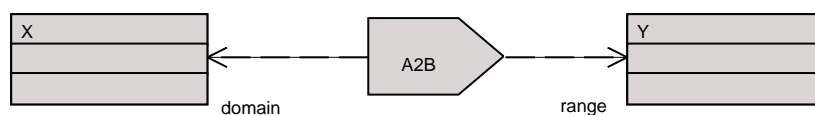

Figure 8.2: An example mapping

The textual syntax of a mapping consists of a mapping declaration, which is equivalent to a mapping arrow on a diagram:

```
@Map <name> (<domain_1>, <domain_2>, ... <domain_n>) -> <range>
```

end

A mapping contains a collection of clauses of the form:

```
@Clause <name>
```

```
  <pattern>
```

end

Note, each clause must have a different name.

A pattern is the mechanism that is used to match values in the domain of the mapping to values in the range. It has the general form:

```
<exp> do
```

```

    <exp>
  where
    <exp>

```

Expressions are written in a mixture of XOCL expressions and patterns expressions, where a pattern expression is a syntactical relationship between expressions containing variables that are bound by pattern matching. A common pattern used in mappings is to relate object constructors. These describe a pattern match between a domain object constructor and a range object constructor subject to there being a pattern match between slot value expressions. An example of this is:

```

X[a = A] do
  Y [b = A]

```

Here the variable, A, is bound to the value of the slot a of any instance of the class X using the expression a = A. This value is then matched with the value of the slot b. The result of this expression will be to match any instance of the class X with the class Y, subject to the value of the slot b being equal to the value of a.

Patterns can contain arbitrarily complex expressions. For instance, this expression matches a with another constructor, which contains a variable c, which is then matched with b:

```

X[a =
  Z[c = A]] do
  Y [b = A]

```

Patterns may also be embedded in sets and sequences:

```

X[a =
  Set{Z[c = A]}] do
  Y [b = A]

```

In this case, the slot a must be an instance of an attribute of type Set(Z) and provided it contains an single instances of Z will be matched.

Patterns can also be used in a very implicit fashion, to state properties of values that must match. For instance, consider the requirement to match a with an object belonging to a set, subject to a slot being of a specific value. This could be expressed as follows:

```

X[a = S->including(Z[c = 1,d = A])] do

```

```
Y [b = A]
```

This will match an object belonging to the set `a` subject to its slot `c` being equal to 1. The value of `S` will be the remaining elements of the set.

The 'where' component of a clause can be used to write additional conditions on the pattern. Consider the following pattern, in which the relationship between the variables `A` and `B` are related by a `where` expression:

```
X[a = A] do
  Y [b = B]
  where B = A + 1
```

Finally, a mapping clause may call other mappings. This is achieved by creating an instances of the mapping, and passing it the appropriate domain values:

```
X[a = A] do
  Y [b = B]
  where B = mapIt(A)
```

Here, the value of `B` is assigned the result of passing the value of `A` to the mapping called `mapIt`. Note that a mapping can also be instantiated and then invoked. This enables values to be passed to the mapping via its constructor, e.g. `mapIt(5)(A)`.

Finally, it is common to iterate over a collection of values, mapping each one in turn. This type of mapping would look like so:

```
X[a = A] do
  Y [b = B]
  where B = A->collect(a | mapIt()(a))
```

This would pass each element of `A` into the `mapIt()` mapping collecting together all their values and assigning them to `B`.

8.7 XMap Examples

This section demonstrates two mappings written using `XMap`: a mapping from `StateMachines` to `Java` and a mapping from `Java` to `XML`. Together they aim to demonstrate the main features of `XMap` and to give an understanding of the essential requirements of a mapping language.

8.7.1 StateMachines to Java

The purpose of this mapping is to translate a StateMachine into a Java class. The source of the mapping is the StateMachines metamodel described in chapter 4 and the class diagram for this metamodel is repeated below.

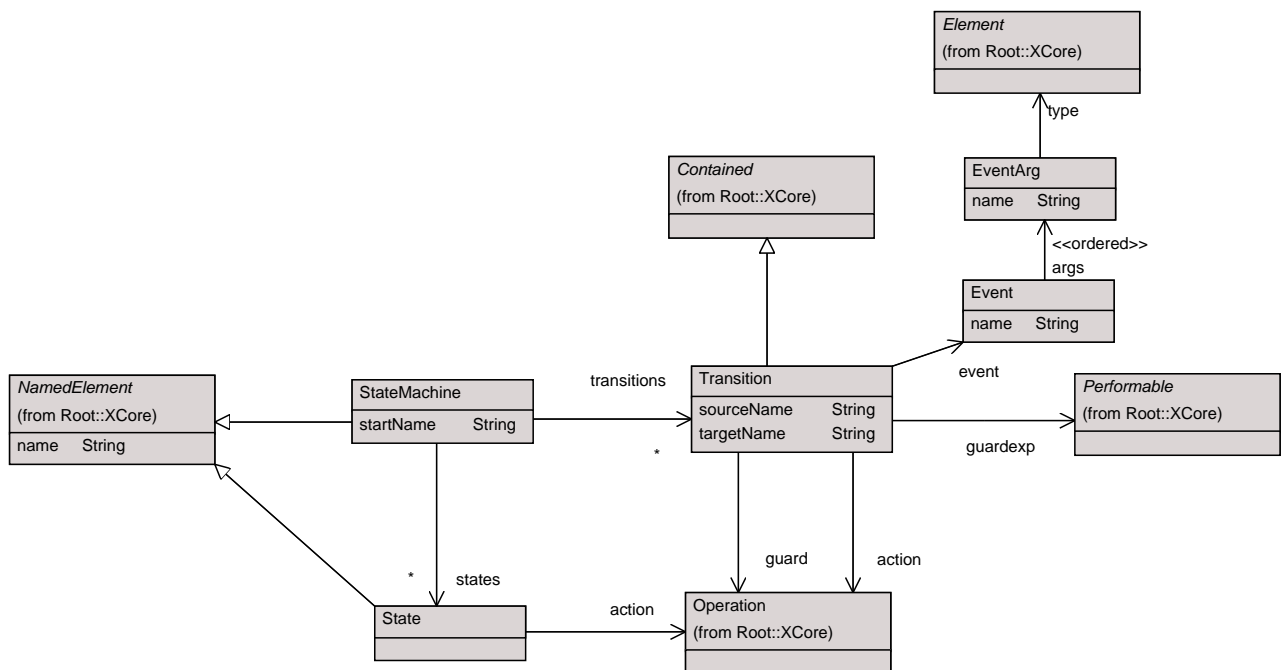

Figure 8.3: The abstract syntax metamodel for StateMachines

The target of the mapping is a simple model of Java as shown in figure 8.4. A Java program is a collection of named classes. A Java class has a collection of member properties, which may be named fields (attributes) or methods. A method has a name, a body and a return type and a sequence of arguments that have a name and a type.

The mapping is shown in figure 8.5. It maps a StateMachine into a Java class with an attribute called state and maps each transition to a method that changes the value of state from the source state to the target state.

The detail of the StateMachine mapping are described by the following code. A mapping consists of a collection of clauses, which are pattern matches between patterns of source and target objects. Whenever a collection of source values is successfully matched to the input of the mapping, the resulting collection of values after the do expression is generated. Variables can be used within clauses, and matched against values of slots in objects. Because XMap builds on XOCL, XOCL expressions can also be used to capture complex relationships between variables.

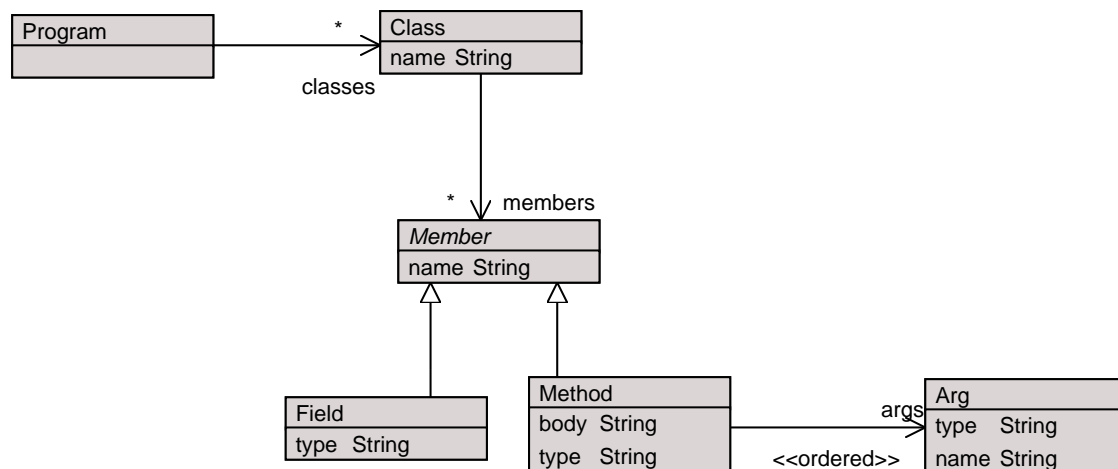

Figure 8.4: The abstract syntax metamodel for Java

```

@Map SM2Class(StateMachines::StateMachine)->Java::Class
@Clause ToClass
  s = StateMachine
  [name = N,
   transitions = T,
   states = S] do
  Class
  [name = N,
   members = M->including(
    Field
    [name = "state",
     type = "String" ])]
  where M = T->collect(t | Transition2Method(t))
  end

```

In this example, whenever the mapping is given a `StateMachine` object with a name equal to the variable `N`, a set of transitions `T` and a set of states `S`, it will generate an instance of the class `Java::Class`. This will have a name equal to `N` and members that includes a single state attribute named "state" and a set of methods, `M`. The where clause is used to calculate the value `M`. It matches `M` with the results of iterating over the transitions, `T`, and applying the `Transition2Method` mapping. The mapping from transitions to Java methods is shown below:

```

@Map Transition2Method(Transition)->Java::Method
@Clause Transition2Method
  t = Transition

```

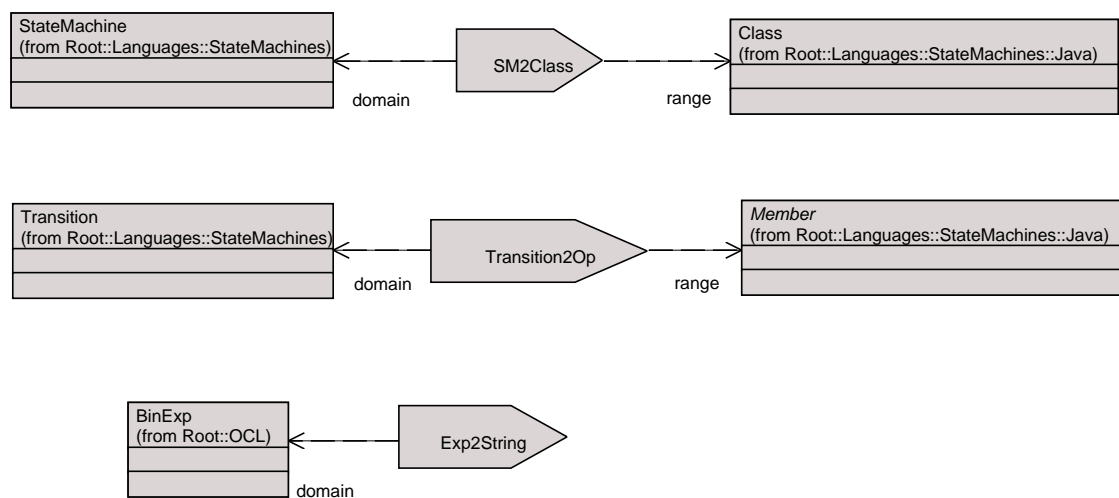

Figure 8.5: The StateMachine to Java mapping

```

    [event = Event[name = N] ] do
Method
    [name = N,
     body = B]
where
    B = "if (" + Exp2String() (t.guardexp.performable) + ") \n" +
        "  this.state := " + "\"" + t.targetName + "\"" + "; \n"

end
end

```

This mapping matches a Transition owning an Event named N to a Java Method with a name N and a body B. This mapping illustrates how patterns can capture arbitrarily nested structures: any depth of object structure could have been captured by the expression.

The definition of the body, B, requires some explanation. Because the mapping generates a textual body, this expression constructs a string. The string contains an "if" expression whose guard is the result of mapping the transition's guard expression (an instances of the OCL metamodel) into a string (see below). The result of the "if" expression is an assignment statement that assigns the state variable to be the target of the transition.

Mapping Guard Expressions

Whilst the above mapping deals with the mapping to the superstructure of Java, it does not deal with mapping the guards and actions of the StateMachine. However, in order to be able to *run* the Java, these will need mapping across too. As an example, the following mapping describes how some sub-expressions of OCL can be mapped into Java code.

```

@Map Exp2String(OCL::BinExp)->String
@Clause BinExp2String
  BinExp
  [binOp = N,
   left = L,
   right = R] do
    self(L) + " " + N + " " + self(R)
  end
@Clause IntExp2String
  IntExp
  [value = V] do
    V
  end
@Clause Dot2String
  Dot
  [name = N,
   target = S] do
    if S->isKindOf(OCL::Self) then
      "self"
    else
      self(S)
    end + "." + N
  end
@Clause BoolExp2String
  BoolExp
  [value = V] do
    V
  end
end

```

This mapping contains a number of clauses, which are matched against an sub-expression of OCL. In order to understand this mapping, it is necessary to understand the OCL metamodel. The relevant fragment of this is shown below in figure 8.6.

The first clause of this expression matches against any binary expression, and generates a string containing the results of mapping the left hand expression followed by the binary operator and the result of mapping the right hand expression. The follow-

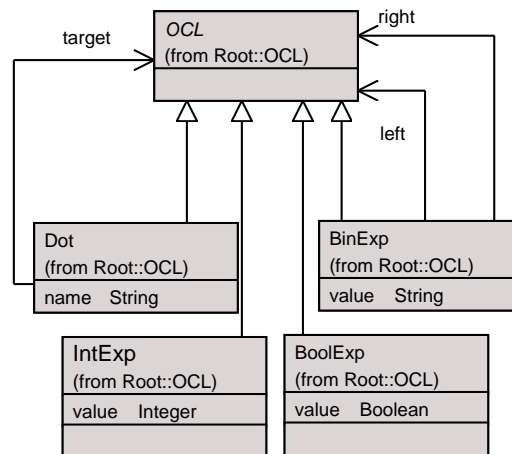

Figure 8.6: Fragment of OCL expression metamodel

ing clauses describe what should happen for integer expressions, dot expressions and boolean expressions.

As an example, consider the StateMachine in figure 6.2. The body of the guard on the GreenRed transition will be parsed into an instance of an OCL expression. The mapping described above will translate the transition and its guard expression into the following Java code:

```
public GreenRed() if (self.count < 10)
    this.state := "Red";
```

8.7.2 Mapping to XML

This section gives an example of using XMap to map between Java and XML. The aim of this example is to illustrate the ability of mappings to record information about the execution of a mapping.

A model of XML is shown in figure 8.7. An XML document consists of a root node, which may be an element, or a text string. Elements can have attributes, which have a name and a value. Elements may also have child nodes.

A mapping between Java and XML maps each element of the Java model (classes, fields, methods and arguments) into XML elements. The relationship between XML elements and their children matches the hierarchical relationship between the elements in the Java model. The mapping diagram is shown in figure 8.8.

The mapping from a Java program to an element is shown below. The operation `getId()` will return an id ref for an element if that element has already been generated,

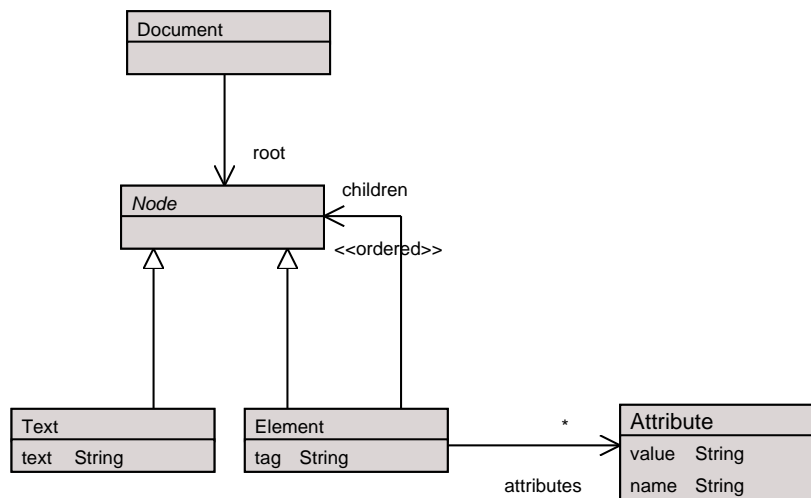

Figure 8.7: Abstract syntax model for XML

alternatively it will create a new one and place it in a table. All subordinate mappings can reach this mapping via their 'owner' slot.

```

@Map MapProg (Java::Program) ->XML::Element

@Attribute mapClass : MapClass = MapClass(self) end
@Attribute idTable : Table = Table(100) end

@Operation getId(name)

  if idTable.hasKey(name) then
    idTable.get(name)
  else
    idTable.put(name, "id" + idTable.keys()->size.toString());
    idTable.get(name)
  end
end

@Clause Program2Element
Program
  [classes = C]
do
Element
  [tag = "Program",
  attributes = Set{},
  children = E]

```

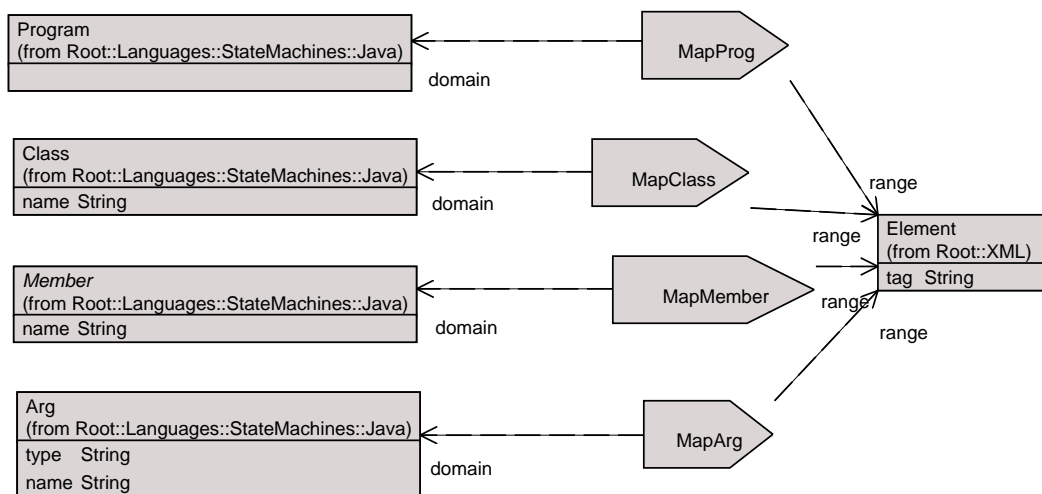

Figure 8.8: Mapping from Java to XML

```

where
  E = C->collect(c | mapClass(c))
end
end

```

The mapping from classes to XML elements is more complicated. It maps a class with name *N* and members *M* to an element tagged as a "Class" containing two attributes. The first attribute corresponds to the name attribute of the class, and thus has the name "name" and value *N*. The second attribute provide an id for the element, which is the result of running its `getId()` operation.

```

@Map MapClass(Java::Class)->XML::Element

@Attribute owner : MapProg end
@Attribute mapMember : MapMember = MapMember(self) end

@Constructor(owner) end

@Operation getId(name)
  owner.getId(name)
end

@Clause Class2Element
  Class
    [name = N,

```

```

    members = M] do
Element
  [tag = "Class",
   attributes =
     Set{}->including(
       Attribute
         [name = "name",
          value = N]->including(
            Attribute
              [name = "id",
               value = self.getId(N)]),
        children = E]
  where
    E = M->collect(m | mapMember(m))
end
end

```

Exactly the same strategy is used to map Field, Methods and Arguments to XML Elements. The following shows the mapping for Fields:

```

@Map MapMember (Java::Member) -> XML::Element

@Attribute owner : MapClass end
@Attribute mapArg : MapArg = MapArg(self) end

@Constructor(owner) end

@Operation getId(name)
  owner.getId(name)
end

@Clause Field2Element
Java::Field
  [name = N,
   type = T] do
Element
  [tag = "Field",
   attributes =
     Set{}->including(
       Attribute
         [name = "name",
          value = N]->including(
            Attribute
              [name = "type",

```

```

        value = self.getId(T)],
    children = Set{}}]
end
end

```

8.8 Mapping Specifications

A mapping specification is useful in describing what a mapping does as opposed to how it is to be implemented. Mapping specifications do not require any additional modelling facilities beyond OCL. As shown in figure 8.9, a mapping specification consists of a number of mapping classes, which sit between the elements of the models that are to be mapped.

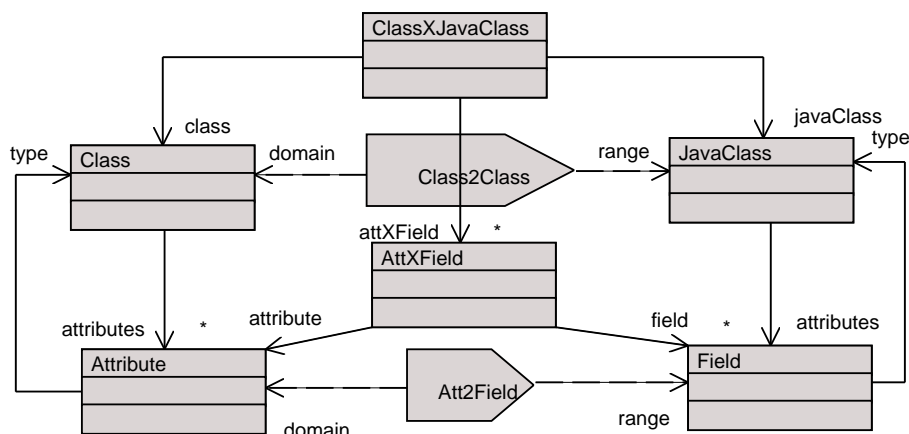

Figure 8.9: An example mapping specification

OCL is then used to define the constraints on the relationship between the models. The following constraint requires that the names of the two classes must be the same.

```

context ClassXJavaClass
@Constraint SameNames
class.name = javaClass.name
end

```

This constraint ensures that there is an AttXField mapping for each attribute owned by a class:

```
context ClassXJavaClass
  @Constraint AttXFieldForClassAtt
    class.attributes = attXField.attribute
  end
```

Similar constraints will be required for Java classes.

Mapping specifications are a useful means of validating a mapping. This can be achieved by firstly specifying the mapping. Next, an implementation of the mapping is designed so that whenever it is run it will generate instances of the appropriate mapping specification classes. The constraints on the mapping specification can then be checked to test that the mapping implementation has satisfied the mapping specification.

8.9 Mapping Issues

8.9.1 Merging

The previous example highlights an important issue that often occurs when writing mappings: how to merge duplicate elements. Duplicate elements typically occur when mapping graph like structures. Elements in the graph may have references to other elements in the graph that have already been mapped. In this situation, naively following the link and mapping the element will result in duplicate elements being generated.

A good example is a mapping between UML and Java (a simplified model is shown in figure 8.10). One way to implement this mapping is to traverse each of the classes in the package, and then map each class and its associated attributes to Java classes and fields. A problem arises because Java classes reference their types (thus introducing a circular dependency). At the point at which a `Att2Field` mapping is executed, the generated `Field`'s type may already have been generated. If the `Att2Field` mapping then generates a new type, it will be duplicated.

There are a number of solutions to this problem:

- Maintain a table of generated elements and check it before generating a new element. The Java to XML mapping described above is an example of this.
- Run the mapping and then merge duplicate elements on a case by case basis. An example of how this is achieved in XOCL can be found in section 7.4.1.
- Use a generic mechanism that can run over object graphs merging duplicate elements. The walker algorithm defined in section 7.4.3 can form the basis for such an algorithm.

In all cases, criteria must be identified for mergeable elements. In above mapping, the criteria for merging two types is that they have the same name. In general, the criteria must be defined on a case by case basis, and accommodated in the mappings.

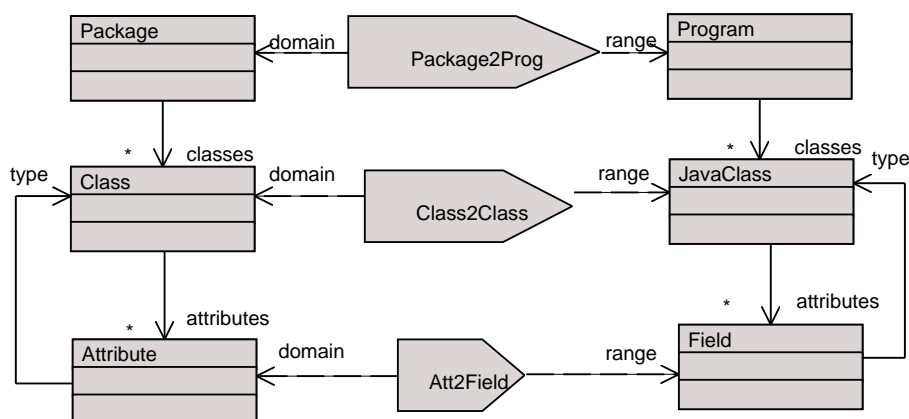

Figure 8.10: A simplified UML to Java mapping

8.9.2 Traceability

A common requirement when constructing mappings is to keep information about the mapping. There are two strategies that can be used to achieve this:

- Create instances of reverse mappings or mapping specifications as the mapping is performed. The result will be a graph of reverse mappings or mapping specifications connecting the domain and range elements.
- Extend the mapping language so that it records a trace of the executed mappings in a generic.

The former approach is most appropriate when wishing to reverse the mapping or check that it satisfies a specification of the mapping. The latter approach is most useful when analysing or debugging a mapping.

8.10 XSync

Very often mappings are required that are not uni-directional, but which synchronise elements, ensuring that if changes occur in one element they are reflected in another. There are many applications of synchronised mappings, including:

- Maintaining consistency between views on a common collection of elements: for instance, keeping diagrams consistent with models and vice versa.
- Managing multiple models of a system: for example, a large systems development project might use multiple tools to design different aspects of a system but be required to maintain consistency where design data overlaps.

- Supporting round trip engineering where models are maintained in sync with code and vice versa.

XSync is a mapping language that permits the modelling of synchronised mappings. It enables rules about the relationship between concepts in two or more models to be captured at a high level of abstraction. Synchronised mappings can be run concurrently, continuously monitoring and managing relationship between elements.

8.10.1 Examples

The following code describes a simple XSync model in which we want to maintain consistency between two instances of a class. The class is defined as follows:

```
context Root
  @Class Point
    @Attribute x : Integer end
    @Attribute y : Integer end
    @Constructor(x,y) ! end
  end
```

We create two instances of the class, p1 and p2:

```
Root::p1 := Point(100,100); Root::p2 := Point(1,2);
```

Now we create a synchronised mapping:

```
Root::n1 :=

@XSync
  @Scope
    Set{p1,p2}
  end
  @Rule r1 1
    p1 = Point[x=x;y=y];
    p2 = Point[x=x;y=y] when p1 <> p2
  do
    "The points match".println()
  end
  @Rule r2 1
    p1 = Point[x=x1];
    p2 = Point[x=x2] when p1 <> p2 and x1 < x2
  do
```

```

    "Incrementing x".println();
    p1.x := x1 + 1
end
@Rule r3 1
  p1 = Point[y=y1];
  p2 = Point[y=y2] when p1 <> p2 and y1 < y2
do
  "Incrementing y".println();
  p1.y := y1 + 1
end
end;

```

A synchronised mapping consists of a scope and a collection of synchronisation rules. The scope of the mapping is the collection of elements over which the mapping applies. In this case, it is the two instances of Point, p1 and p2.

A rule describes the condition under which an action should occur. Actions are used to describe synchronisations but they may also cause other side effects. This is important because in practice it is often necessary to perform other tasks such as generating reports, modifying values and so on.

A rule takes the form of a pattern, a boolean 'when' clause and a 'do' action. Provided that the 'when' clause is satisfied by variables introduced by a matched pattern, the 'do' action will be invoked.

In this example, rule r1 checks to see whether p1 and p2 match against instances of Point that have the same x and y values. If they do, and p1 and p2 are not the same element, the 'do' action is invoked to display a message. Rule r2 matches the x values of p1 and p2 against the variables x1 and x2. If x1 is less than x2, the value of p1's x is incremented. Rule r3 does the same for the y values. The result of running this mapping with two points with different x or y values will be to increment the values until they are synchronised.

The previous example is limited as it is fixed to two specific instances. The following shows how a synchronisation mapping can be parameterised by an operation:

```

context Root
  @Operation sameName(c1,c2)
  @XSync
  @Scope
    Set{c1,c2}
  end
  @Rule r1 1
    x1 = Class[name = n1] when x1 = c1;
    x2 = Class[name = n2] when x2 = c2 and n1 <> n2
    do x1.name := x2.name
  end

```

```
end
end
```

This mapping applies to any pair of classes and synchronises the name of the first with the second. Such a mapping would be useful for synchronising concrete syntax classes and abstract syntax classes, for example see chapter 5.

This section has provided a short introduction to the XSync synchronisation language. Future versions of this book will explore a number of deeper issues, including its application to the synchronisation of complex structures, and the different execution models it supports.

8.11 Conclusion

Mappings are a central part of Language-Driven Development as they enable key relationships between many different types of problem domain to be captured. Mappings exist between vertical, horizontal and variant dimensions of a problem domain. In the context of languages, mappings are needed to synchronise abstract and concrete syntaxes and to relate models and programs written in different languages.

CHAPTER 9

REUSE

9.1 Introduction

Languages are hard to design. The effort that goes into producing a language definition can be overwhelming, particularly if the language is large or semantically rich. One way to address this problem is to find ways of designing languages so that they are more reusable and adaptable. By reusing, rather than re-inventing, it is possible to significantly reduce the time spent on development, allowing language designers to concentrate on the novel features of the language.

This chapter looks at techniques that can be used to design reusable metamodels. These include approaches based on the use of specific extension mechanisms such as stereotyping and class specialisation, and richer mechanisms that support the large grained extension of modelling languages, such as meta-packages and package specialisation. An alternative approach based on the translation of new concepts into pre-defined is also discussed.

The following sections examine each of these approaches in turn, identifying their advantages and disadvantages and offering practical advice on their application.

9.2 Extension Based Approaches

This approach involves extending and tailoring concepts from an existing metamodel. The most common mechanisms for implementing extension are class specialisation and stereotyping.

9.2.1 Specialisation

Specialisation has been widely used as a reuse mechanism by OO programming languages for many years. Since XMF is an OO metamodelling language, it is not surprising that this mechanism can also be used to reuse language concepts.

One of the best ways to support this approach is to provide a collection of classes (a framework) that supports a collection of reusable language concepts. These concepts can then be specialised to support the new language concepts.

The XCore framework (see section 9.5) aims to support the abstractions found in popular metamodelling frameworks such as MOF [mof00] and EMF [emf08] at a usable level of granularity. An important difference between XCore and other frameworks is that XCore is a platform independent, executable language with a precisely defined syntax and semantics. This means that these semantics can be extended as well to rapidly define semantically rich language concepts. For example, if the class `XCore::Class` is specialised by the class `X`, all instances of `X` will inherit the properties of a class, including the following:

- They can be instantiated.
- They can have attributes, operations and constraints.
- They can be serialized.
- Their instances can be checked against any constraints.
- Their operations can be invoked on their instances.
- They have access to the grammar and diagram syntax defined for classes.

Furthermore, because the class `Class` also specialises `Object`, all operations that apply to an `Object` can also be applied to instances of `X`, such as executing its meta-operations, mapping it to another concept and so on.

Having an executable semantics for a metamodelling framework adds significant value because semantics can be reused along with the structural properties of the language concepts.

Example

Consider the requirement to model the concept of a mapping. A mapping has the following properties:

- It has a domain, which is a collection of input types to the mapping.
- It has a range, which is the result type of the mapping.
- A mapping can be instantiated and the state of a mapping instance can be recorded.

- Operations can be defined on an mapping and can be executed by its instances.
- A mapping owns a collection of clauses that define patterns for matching input values to output values.
- A mapping instance can be executed, matching inputs to clauses and resulting in an output value.

Many of these properties can be reused from existing XCore concepts, thus avoiding the need to model them from scratch. The model in figure 9.1 shows how this might be done by specialising the class Class.

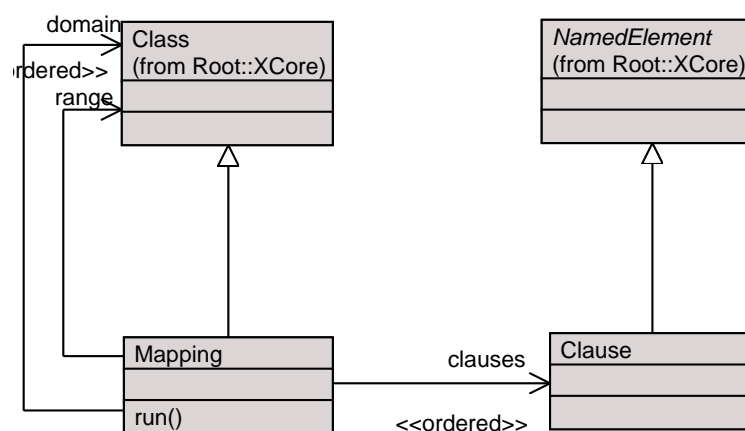

Figure 9.1: Reuse of the class Class to define a new Mapping concept

The mapping class reuses all the properties of Class, including attributes, operations and the machinery to support instantiation and operation invocation. Other properties, such as having domain and range types, and executing mappings are layered on top.

9.2.2 Stereotyping, Tags and Profiles

Stereotypes are a widely used device that enable existing modelling concepts to be treated as virtual subclasses of an existing metamodeling class. This is achieved by associating metamodel classes with information about what stereotypes they may support. An example of this might be to stereotype the class Class as a Component and the class Association as a Component Connector.

Tags and tagged values are closely related to stereotypes. These have the same effect as extending metamodel classes with additional attributes and information about the values these attributes may be assigned. An example of tag and tagged value might be the tag "visibility" attached to an Operation, which can have the values, "public", "private" or "protected".

Together, stereotypes and tags can be used to create what is called a *profile*: a collection of stereotyped concepts that form the vocabulary of a new or hybrid modelling language.

Many UML tools provide support for stereotypes, tags and tagged values, allowing them to be visually displayed in an editor with an appropriate identifier. Figure 9.2 shows a class diagram with two stereotyped classes and a stereotyped association.

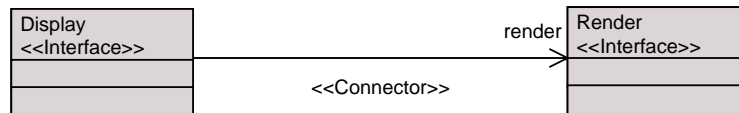

Figure 9.2: Using stereotypes to model interfaces and connectors

The advantage of stereotypes and tags is that they add a convenient level of tailorability to modelling tools that would otherwise be unavailable.

Nevertheless, stereotypes and tags suffer from being semantically weak and are not a replacement for a well-defined metamodel of the language. As the example in figure 9.3 shows, they offer little control over the correct usage of the language: for instance, a model written in a component modelling language might not permit interfaces to be connected to classes, yet this will not be ruled out by stereotypes. Furthermore, stereotypes are not able to capture the semantics of a language as they cannot change the properties of meta-classes.

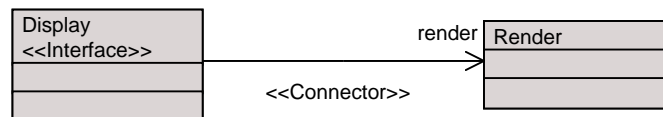

Figure 9.3: An example of inconsistencies that can arise through the use of stereotypes

While UML profiles [uml01] allow additional constraints to be defined on stereotypes, there are few if any tools available that support this capability.

9.2.3 Package specialisation and Meta-Packages

Although specialisation can be used to directly extend metamodel concepts, this is a significantly more involved process than defining stereotypes because a concrete syntax for the concepts will also have to be modelled if they are to be used in a tool. A better solution would be one that combines the simplicity of stereotypes with the power of specialisation.

One way of achieving this is through the use of *package specialisation* and *meta-packages*. Package specialisation is a relationship between two packages where the child package

specialises the parent package. The consequence of this is that it enables a package of language concepts to be clearly identified as extensions of a package of existing language concepts (the parent package).

As an example, figure 9.4 shows a package of component concepts specialising the XCore package.

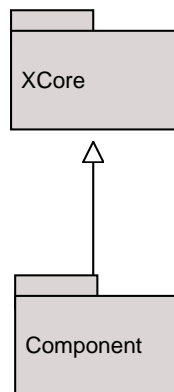

Figure 9.4: Specialising the XCore package

Inside the components package some choices are made about the XCore classes that are to be specialised. These are shown in figure 9.5. Additional constraints can be added to rule out certain combinations of components, for example, a connector must always connect two interfaces.

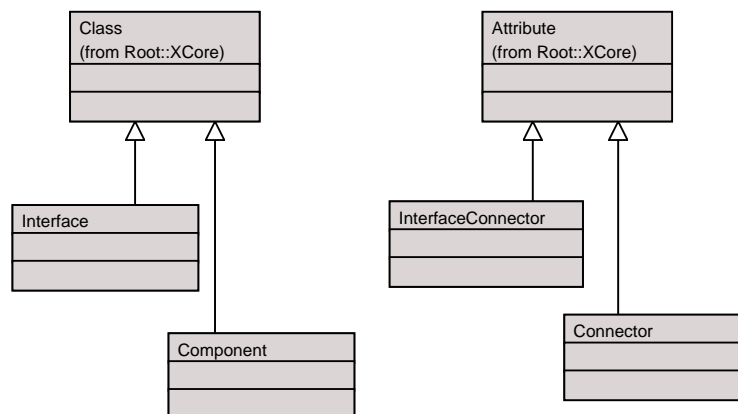

Figure 9.5: specialising XCore concepts

This provides sufficient information to determine whether a concept should be represented as a native concrete syntax element or as a stereotyped element. However, a

way must now be found of *using* the specialised package. This is where meta-packages come in useful. A meta-package is a package of elements that are instances of elements in another package (the meta-package). In the components example, a package containing a model written in the components language is related to the components package by a meta-package relationship (see figure 9.6).

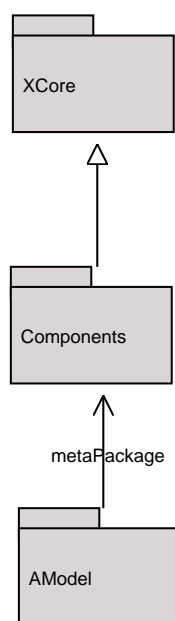

Figure 9.6: A metapackage relationship between a model and the components package

If a tool understands that the model is an instance of a package that specialises the XCore package it can provide appropriate stereotypes for each of the specialised elements (see figure 9.7 for an example). These stereotyped elements can be used to construct models, which can then be checked against any constraints in the components package. Because the stereotyped elements are real instances of meta-model elements all the semantics inherited from XCore will be available as well.

Meta-packages are a more generic concept than just a mechanism for dealing with concrete syntax. Consider a language expressed as a meta-package that already has tools developed for the language. If a new language differs from the existing one in a few minor but important ways we would like to make use of the existing tools but clearly work with the new language. The new language can be defined as an extension of the meta-package. A package whose meta-package is the new languages can thus be supplied to the development tools using the standard principle of substitution.

If tools are generic with respect to the meta-package, then it can tailor itself by providing specific instances of functionality for each new language feature that is a sub-class of a corresponding feature in the meta-package. This may cover a wide range of different aspects of tool functionality.

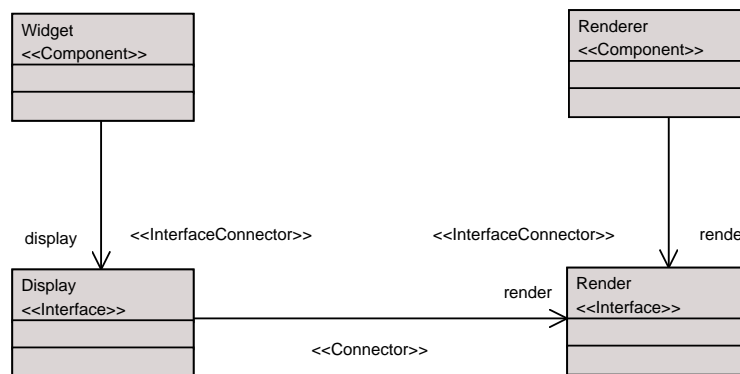

Figure 9.7: A model written in the components language

As an example, imagine that a configuration management tool expects instances of any sub-package of XCore and provides facilities such as rollback, model-merge etc, based on all the sub-classes of Class, Association, Attribute etc then a wide variety of development tools can be constructed each of which works with a different language but which all use the same development code.

9.3 Translation Based Approaches

The aim here is to define new modelling concepts by a translation to existing concepts that implement their required properties. As described in chapter 8, there are a variety of ways of translating between metamodel concepts. These include:

- Defining a translation from the concrete syntax of a concept to an appropriate abstract syntax model written in another language. The new language is thus a sugar on top of the existing language.
- Translating from the abstract syntax of the new concept into the appropriate abstract syntax model.
- Maintaining a synchronised mapping between concepts.

By translating into an existing primitive, the effort required to model the semantics of the new concept is significantly reduced. The translation approach is akin to a compilation step, in which new concepts are compiled into more primitive, well-defined concepts. The advantage is that layers of abstraction can be built up, each ultimately based on a core set of primitives support by a single virtual machine. This greatly facilitates tool interoperability as the virtual machine becomes a single point of tool conformance.

9.3.1 Example

A common approach to implementing associations is to view them as a pair of attributes and a constraint, where associations between classes are implemented as attributes on each class plus a round-trip constraint that must hold between instances of the classes. A translation can be defined between an association model (either expressed as concrete or abstract syntax) and the more primitive concept of class and attribute.

9.4 Family of Languages

As the number of languages built around a metamodeling language architecture grows, it is very useful to be able to manage them in a controlled way. One approach is to organise them into families of languages [CKM⁺99]. In a family of languages, each member is related to another language through its relationship to a common parent. The result is a framework of languages that can be readily adapted and combined to produce new language members: in other words a language factory or product line architecture.

There are a number of mechanisms that are useful realising such a framework. Packages are a good mechanism for dividing languages into language components, which can be combined using package import. An example of such an architecture is shown in figure 9.8.

Packages can be broken down further, both vertically and horizontally. Vertical decomposition decomposes a language into a sub-language components that incrementally build on each other. An example might be an expression language that is arranged into packages containing different types of expressions: binary, unary and so on.

A horizontal decomposition breaks a language into different aspects. It makes sense to make a distinction between the concrete syntax, abstract syntax and semantic domain of the language component (see figure 9.9).

9.5 The XCore Framework

Figure 9.10 shows the class framework for XCore. This framework is based on a combination of MOF and other metamodeling frameworks such as Ecore with necessary extensions to support executability. As such it should be viewed as an example of a typical metamodeling language framework.

Within this framework there are a number of abstract classes that encapsulate the generic properties of common types of language concepts. The following table identifies some of the key ones:

Classifier A classifier is a name space for operations and constraints. A classifier is generalizable and has parents from which it inherits operations and constraints. A classifier can be instantiated via `new()`. In both cases the default behaviour is to

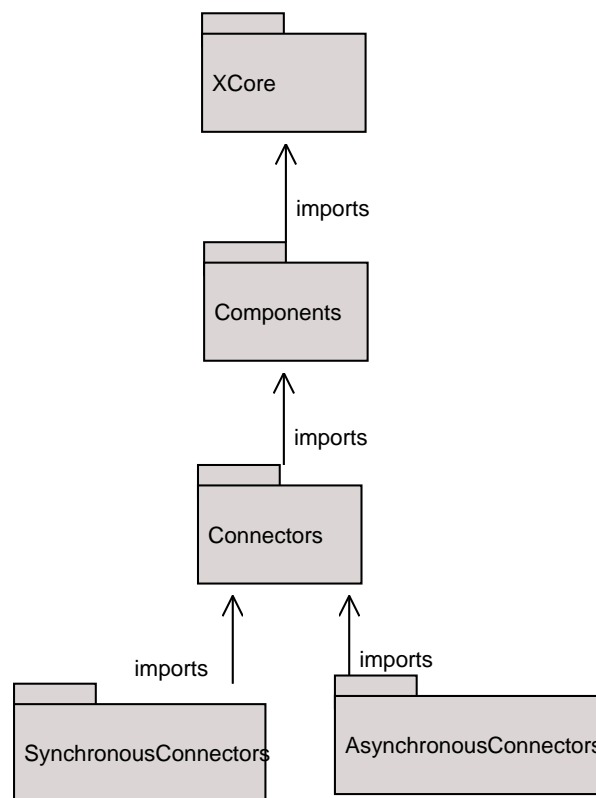

Figure 9.8: A language architecture

return a default value as an instance. If the classifier is a datatype then the basic value for the datatype is returned otherwise 'null' is returned as the default value. Typically you will not create a Classifier directly, but create a class or an instance of a sub-class of Class.

Container A container has a slot 'contents' that is a table. The table maintains the contained elements indexed by keys. By default the keys for the elements in the table are the elements themselves, but sub-classes of container will modify this feature accordingly. Container provides operations for accessing and managing its contents.

DataType DataType is a sub-class of Classifier that designates the non-object classifiers that are basic to the XMF system. An instance of DataType is a classifier for values (the instances of the data type). For example Boolean is an instance of DataType - it classifies the values 'true' and 'false'. For example Integer is an instance of DataType - it classifies the values 1, 2, etc.

NamedElement A named element is an owned element with a name. The name may

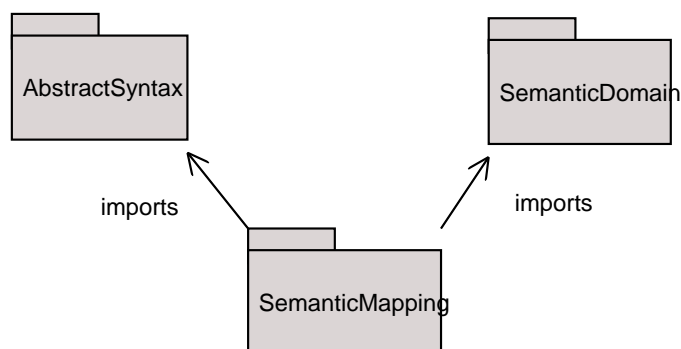

Figure 9.9: Horizontal language components

be a string or a symbol. typically we use symbols where the lookup of the name needs to be efficient.

Namespace A name space is a container of named elements. A name space defines two operations `getElement()` and `hasElement()` that are used to get an element by name and check for an element by name. Typically a name space will contain different categories of elements in which case the name space will place the contained elements in its contents table and in a type specific collection. For example, a class is a container for operations, attributes and constraints. Each of these elements are placed in the contents table for the class and in a slot containing a collection with the names 'operations', 'attributes'; and 'constraints' respectively. The special syntax '::' is used to invoke the `getElement()` operation on a name space.

StructuralFeature This is an abstract class that is the super-class of all classes that describe structural features. For example, `Attribute` is a sub-class of `StructuralFeature`.

TypedElement A typed element is a named element with an associated type. The type is a classifier. This is an abstract class and is used (for example) to define `Attribute`.

9.6 Conclusion

This chapter has shown the importance of being able to reuse language definitions rather than having to design new languages from scratch. Two approaches were presented: specialisation and translation. specialisation involves reusing pre-existing language concepts via class specialisation. A framework of language concepts is important for this purpose. The advantage of the approach is that it enables tools to rapidly adapt their functionality to support new concepts. Translation involves mapping new con-

cepts to existing concepts. It is particularly useful when constructing layered definitions in which richer abstractions are translated down onto more primitive abstractions.

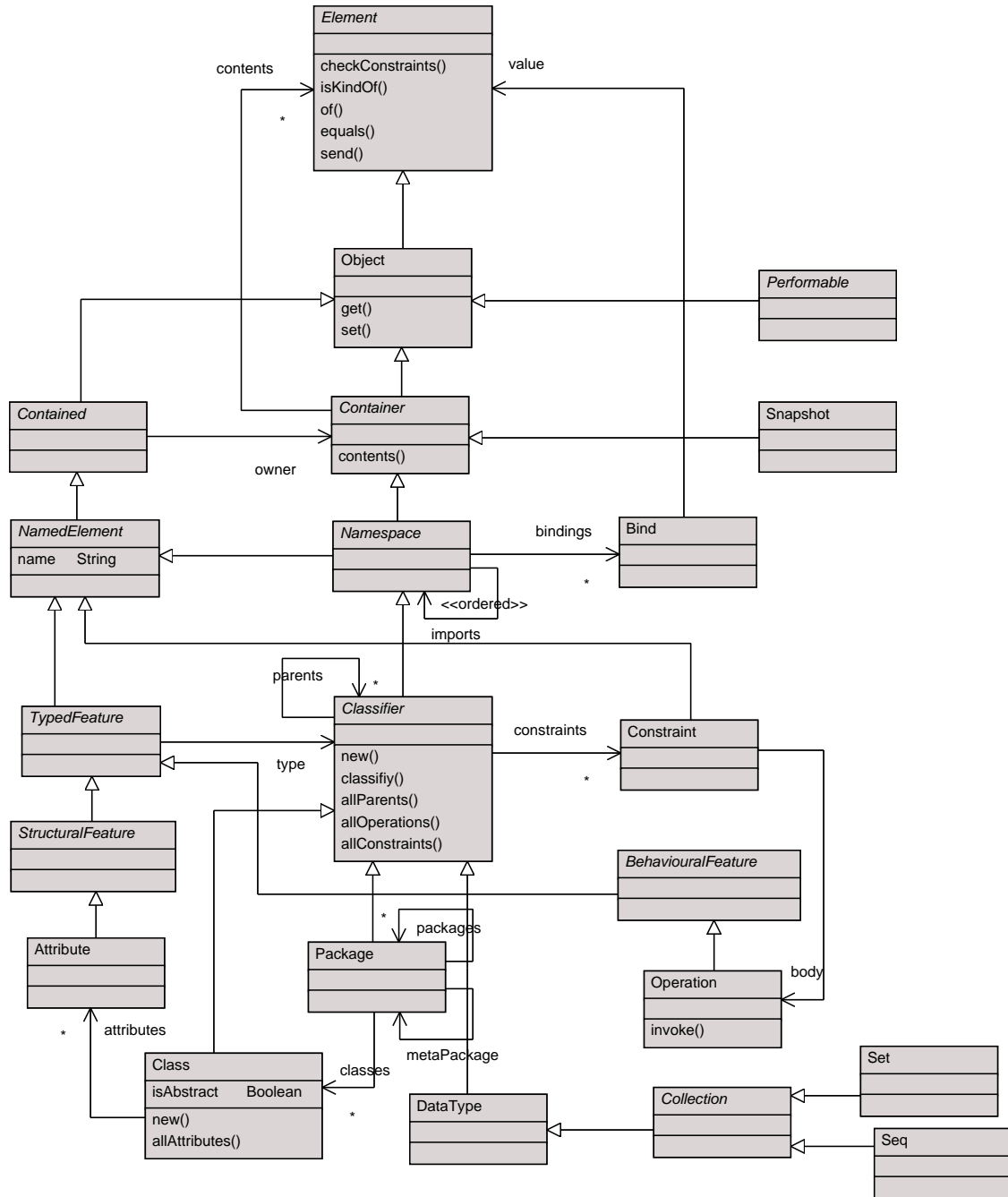

Figure 9.10: Overview of the XCore class framework

CHAPTER 10

CASE STUDY 1: AN ASPECT-ORIENTED LANGUAGE

10.1 Introduction

This chapter presents a metamodel for a simple aspect-oriented language (AOL). We construct an abstract syntax model for the language, along with an operational semantics and a concrete syntax definition.

10.2 AOL

The AOL enables different aspects of components to be modelled separately from the component itself, thus facilitating the separation of concerns. The AOL is a general purpose language because it can be applied across multiple languages provided that they can access its metamodel. An example of its syntax is shown below:

```
@Aspect <name>
...
  @Class <path>
    <namedelement>
    ...
  end
end
```

The aspect named <name> adds one or more named elements to the class referenced by the path <path>. In the version of AOL presented here, classes are the components

that aspects are added to, but in practice any element can be viewed as a component.

As an example, consider the requirement to extend the class `Box` with the ability to generate SVG (Scalable Vector Graphics). Rather than merging this information into the class definition, an aspect can be used to separate out this additional capability:

```
@Aspect ToSVG
@Class Box
@Operation toSVG(parentx,parenty,out)
  if self.shown() then
    format(out,"<rect x=~S\" y=~S\" width=~S\" height=~S\"
    fill =\##DBD5D5\" stroke=\"black\" stroke-width=\"1\"/>~\%",
    Seq{parentx+x,parenty+y,width,height});
    @For display in displays do
      display.toSVG(parentx+x,parenty+y,out)
    end
  end
end
end
end
```

It is important to note that this is a much simpler mechanism than that used by aspect-oriented programming languages such as AspectJ. Nevertheless, it is still a useful and practical mechanism for separating out different aspects of a model.

10.3 Language Definition Strategy

The approach taken to defining the syntax and semantics of this language is to clearly separate syntax concepts from semantic concepts. Parsing the concrete syntax for AOL results in an intermediate abstract syntax definition, which is then desugared into a model of the AOL's operational semantics.

10.4 Abstract Syntax

10.4.1 Identification of Concepts

Based on the example shown above the following candidates for concepts can be immediately identified:

Aspect An aspect has a name and contains a collection of components.

Class A class is a syntax concept that has a path to the class that the named element is to be added to. A class is also a component.

NamedElement The element that is added to the class referenced by its path.

10.4.2 Abstract Syntax Model

An extended abstract syntax model is shown in figure 10.1.

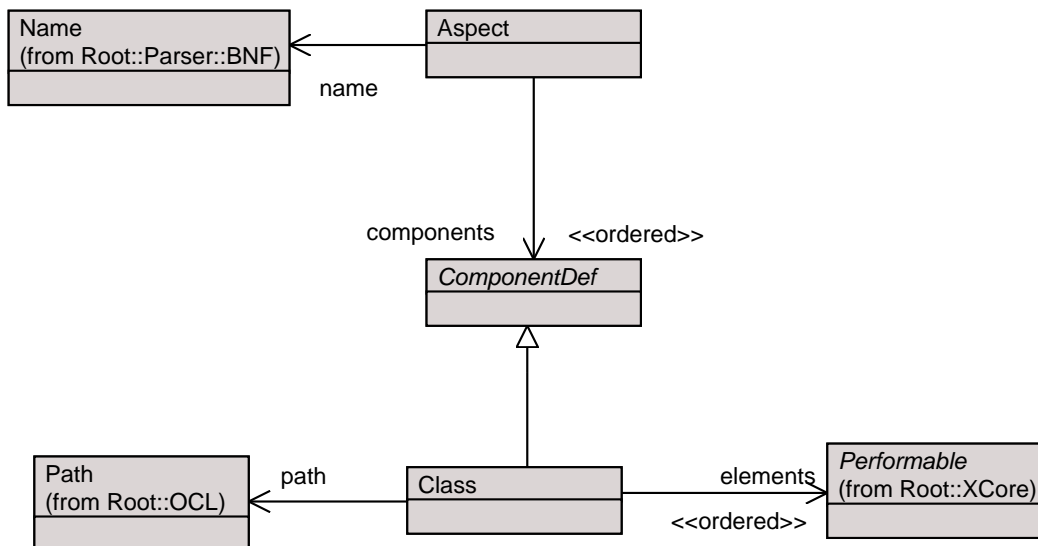

Figure 10.1: An abstract syntax model for AOL

There are a number of points to note about the model:

- Aspects have a name and are containers of component definitions. A component definition is the abstract superclass of all aspect component definitions
- Class specialises component and has a path to the class that its elements are to be added to. The elements of Class are of type Performable (the Root class for all parsable elements).
- Class is not the class XCore::Class, but is purely a syntactical concept.

10.5 Semantics

The abstract syntax model focuses purely on syntax and does not define a semantics. This is important for the AOL because there is a clear separation between the language's syntax and the result of parsing the syntax, which is to add a new named element to an existing class.

To specify the semantics of the language we must therefore build a semantic model. This is presented in figure 10.2.

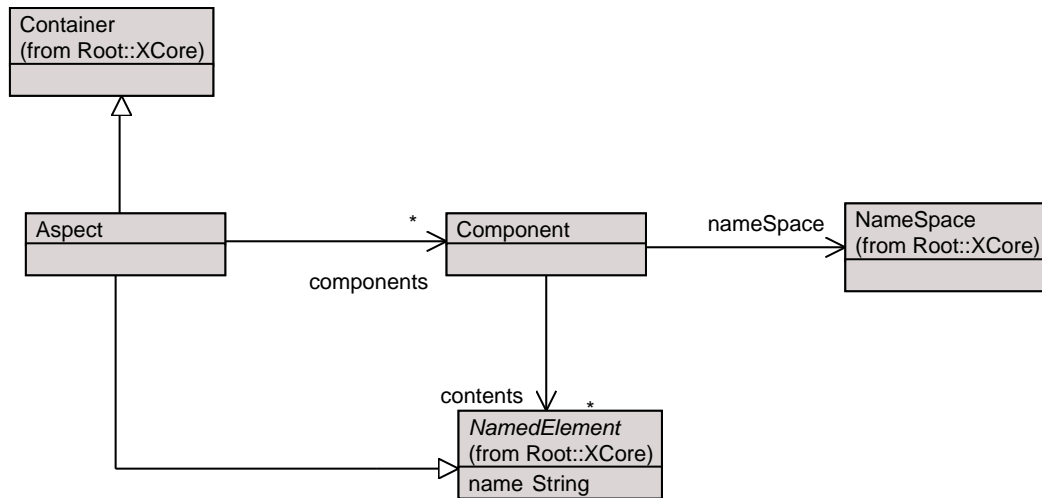

Figure 10.2: A semantic model for the AOL

A component has a namespace and a collection of named elements that are to be added to the namespace.

The following operation is required in order to add elements to a component:

```

context Component
  @Operation add(e:NamedElement)
  self.contents := contents->including(e)
end
  
```

The semantics of adding a named element to the namespace referenced by the component is defined by the following operation:

```

context Component
  @Operation perform()
  @For e in self.contents do
    namespace.add(e)
  end
end
  
```

10.6 Concrete Syntax

A concrete syntax for the AOL is defined in XBNF as follows. An aspect is a name followed by a sequence of component definitions. The result of parsing an aspect is to create an instance of the abstract syntax class Aspect.

```
Aspect ::= name = Name components = (ComponentDef)* { Aspect(name,
    components) }.
```

An aspect is then desugared into an instance of the semantics class Aspect:

```
context Aspect
  @Operation desugar()
    components->iterate(c e = [| Aspects::Semantics::Aspect(<StrExp(
        name)>) |] | [| <e>.add(<c>) |])
  end
```

An abstract syntax class definition is a path followed by a sequence of expressions, which are the result of parsing the elements that are to be added to the class:

```
Class ::= path = Path elements = Exp* { Class(path,elements) }.
Path ::= root = VarExp names = ('::' Name)* { Path(root,names) }.
```

Desugaring an abstract syntax class creates an instance of the class Semantics::Component whose namespace is the class given by the path of the syntax class, and whose elements are the named elements of the abstract syntax class:

```
context Class
  @Operation desugar()
    elements->iterate(c e = [| Aspects::Semantics::Component(<path>)
        |] | [| <e>.add(<c>) |])
  end
```

Once the desugaring process has occurred, the perform() operation will be run on each component to add the named elements to the class referenced by its path.

10.7 Conclusion

This chapter has shown that the key features of a simple aspect-oriented language can be captured within metamodels. The strategy taken was to keep the abstract syntax and semantic models separate and use the concrete syntax definition to firstly create an instance of the abstract syntax model, and then desugar it into an instance of the semantic model.

CHAPTER 11

CASE STUDY 2: A TELECOMS LANGUAGE

11.1 Introduction

This chapter presents an example of the definition of a domain specific modelling language: a telecoms modelling language. The approach taken is to extend the XCore metamodel and to use package extension and metapackages to construct stereotyped concrete syntax elements for the language. Mappings are then constructed from the language metamodel to a metamodel of Java and a metamodel of a user interface language. The work presented in this chapter is based on an earlier case study described in [GAC⁺04].

11.2 The Case Study: OSS/J Inventory

Developing and operating Operational Support Systems (OSS) for telecommunications companies (telcos) is a very expensive process whose cost continuously grows year on year. With the introduction of new products and services, telcos are constantly challenged to reduce the overall costs and improve business agility in terms of faster time-to-market for new services and products. It is recognised that the major proportion of overall costs is in integration and maintenance of OSS solutions. Currently, the OSS infrastructure of a typical telco comprises an order of O(1000) systems all with point-to-point interconnections and using diverse platforms and implementation technologies. The telecoms OSS industry has already established the basic principles for building and operating OSS through the TMF NGOSS programme [NGOSS] and the OSS through Java initiative [oss04]. In summary, the NGOSS applies a top-level approach through the specification of an OSS architecture where:

- Technology Neutral and Technology Specific Architectures are separated.
- The more dynamic "business process" logic is separated from the more stable "component" logic.
- Components present their services through well defined "contracts"
- "Policies" are used to provide a flexible control of behaviour in an overall NGOSS system.
- The infrastructure services such as naming, invocation, directories, transactions, security, persistence, etc are provided as a common deployment and runtime framework for common use by all OSS components and business processes over a service bus.

The case-study was based upon OSS component APIs specified in Java and J2EE by OSS/J. The case-study was specifically driven by the OSS/J Inventory component API [Gau04] and set as its goal to automatically conduct compliance tests between the API specification and the results of the case study. This end acquired more value by the fact that this particular API specification lacks, as of yet, a reference implementation and compatibility kit that would permit its practical validation.

The exercise had two main objectives:

- Construction of a domain specific language metamodel for the OSS/J Inventory: The OSS/J Inventory specification document includes a UML class diagram of an inventory meta-model and some textual, i.e. informal, description of its semantics. The meta-model defines the types of information/content the inventory will manage, such as products, services and resources.
- Automatic generation of a system implementation conforming to standard OSS/J architectural patterns and design guidelines: In order to comply with the OSS/J guideline, the case-study aims at implementing an application tool that allows users to manage the inventory content through a simple GUI. Example users of such a tool may be front-desk operators who respond to customer calls and access the inventory to setup a new or change the state of an existing product/service instance.

Figure 11.1 shows how a language definition for the inventory modelling language was constructed. Firstly, a metamodel for the inventory DSL was defined by extending the XCore meta-model. XOCL was used to specify meta-model constraints so that models written in the inventory language can be checked for correctness. That is, by means of XOCL, the meta-model semantics can be formally captured and automatically enforced, in contrast to the informal, textual description of the semantics presented in the OSS/J Inventory API specification document. Next, mapping rules written in XMap were constructed to transform the inventory meta-model into meta-models of two target platform specific languages: EJB and Java.

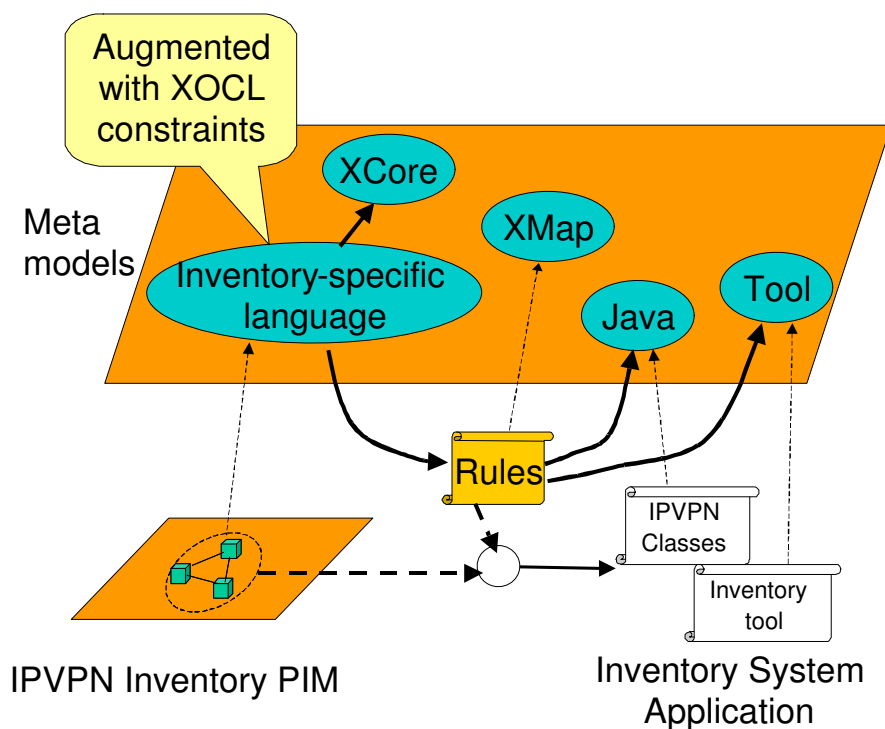

Figure 11.1: Overview of the inventory language definition

11.3 Abstract Syntax Model

Figure 11.2 shows the abstract syntax model for the inventory language. As mentioned earlier, it includes concepts from the OSS/J Core Business Entities, which are a subset of TMF's NGOSS standard. The inventory language consists of the following constructs:

- Entity, that represents any type of information included in the inventory. According to the specification, three types of inventory content are defined, namely, Product, Service and Resource, which extend type Entity.
- EntitySpecification, that represents configurations of Entities, i.e. constraints, such as range of values or preconfigured setting on features of the Entity. Again, the API specification defines three subtypes of EntitySpecification, namely, ProductSpecification, ServiceSpecification and ResourceSpecification, each representing specifications for Service, Product and Resource, respectively. EntityAttribute, that represents relationships between Entity types.

A number of concepts from the XCore package are specialised in order to reuse their syntax and semantics:

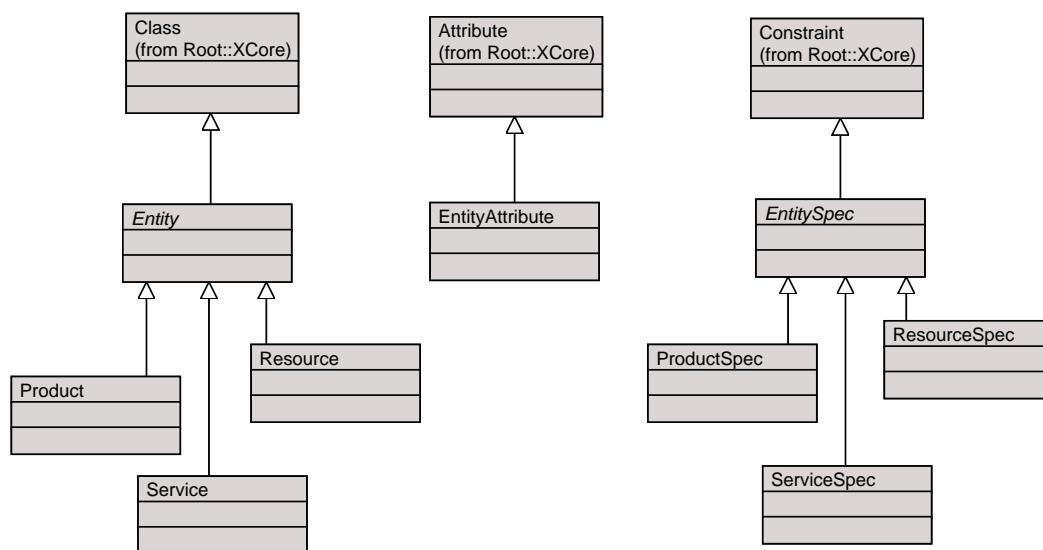

Figure 11.2: The abstract syntax model for the inventory language

- Entity specialises the class `XCore::Class`, hence it can be instantiated and contain attributes, operations and constraints.
- EntitySpecification specialises `XCore::Constraint`. It can, therefore, be owned by an Entity and contain an evaluate-able XOCL expression. In the Inventory API specification document, EntitySpecification is represented as a UML class, which has a simple semantics, and thereby great modelling incapacity to express in full potential the concept semantics as an Entity configuration constraint. Therefore, by modelling EntitySpecification as a pure constraint, rich expressive power is conveyed to the concept enabling it to represent complex Entity configurations.
- EntityAttribute specialises the class `XCore::Attribute` and is used to associate different Entity types.

11.3.1 Well-formedness Rules

A number of constraints (well-formedness rules) apply to the inventory language. These are expressed in OCL. As an example, the following OCL constraint states that if an Entity specialises another Entity it must be of the same type as the parent entity. That is, entity `IPStream.S` of figure 11.3, for instance, can inherit from `IPStream`, as both are of type `Service`, but cannot inherit from `IPVPN` that is of type `Product`. Here, `of()` is an XOCL operation that returns the meta-class of the entity (i.e. the class that the entity is an instance of).

```

context Entity
  @Constraint SameParentType
  parents->select(p |
    p.isKindOf(Entities::Entity)->forall(p |
      p.of() = self.of())
  )
end

```

Another noteworthy constraint, formally delivering an important semantic property of the OSS/J Inventory API specification, involves the association of an Entity type with the correct type of EntitySpecification. In other words, classes of type Service, for instance, can only have specifications of type ServiceSpecification and not of type ProductSpecification or ResourceSpecification. The XOCL for the constraint follows:

```

context Entity
  @Constraint CorrectSpecs
  self.constraints->forall(c |
    let ctype = c.of()
    in @Case ctype of
      [ IML::Entities::ServiceSpec ] do
        self.isKindOf(IML::Entities::Service)
      end
      [ IML::Entities::ProductSpec ] do
        self.isKindOf(IML::Entities::Product)
      end
      [ IML::Entities::ResourceSpec ] do
        self.isKindOf(IML::Entities::Resource)
      end
    end
  )
end

```

11.4 Concrete Syntax

Because package extension and meta-packages (see section 9.2.3) will be used to introduce stereotyped diagram elements for the language, there is no need to define a separate concrete syntax model.

11.5 Semantics

Because all concepts in the inventory language specialise XCore concepts that already have an executable semantics, and the concepts add no further semantic properties,

there is no need to define a separate model of semantics.

11.6 Instantiation

In figure 11.3 an inventory model is presented, which is an instance of the inventory specific metamodel (its meta-package). It illustrates a subset of an IP Virtual Private Network (IPVPN) product. The model shows an IPVPN containing (containedServices attribute) many IPStream entities, an ADSL service that comes in different offerings for home and for office premises represented by IPStream_S and IPStream_Office, respectively. IPStream_S is further specialised by IPStream_S500, IPStream_S1000 and IPStream_S2000, entities differentiating on the downstream bandwidth of the link that is, respectively, 500, 1000 and 2000 kbps. Individual features of the latter entities are defined in the accompanying ServiceSpec constraints, namely, S500Spec, S1000Spec and S2000Spec. Similarly, features of the IPVPN product and the IPStream_S service are specified in the IPVPNSpec and IPStream_SSpec specification constraints.

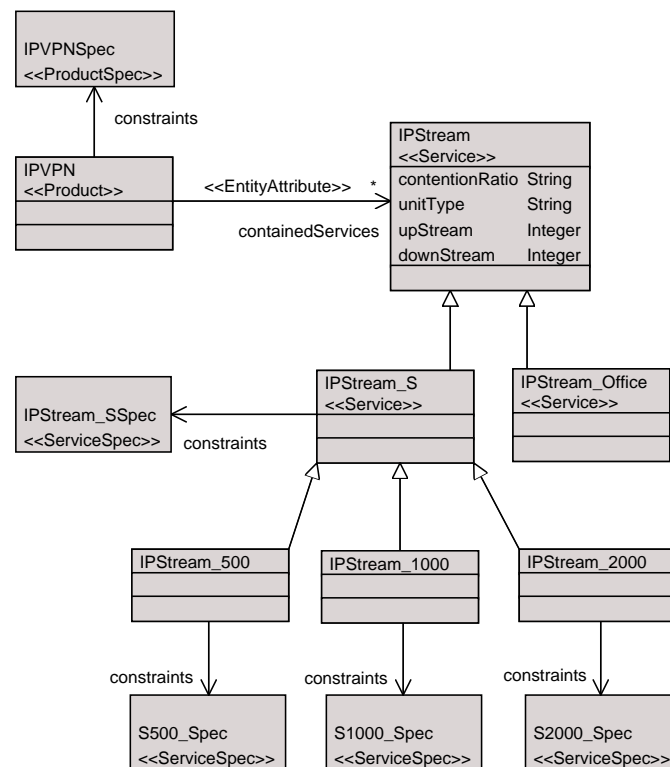

Figure 11.3: An inventory model

Because all model entities of figure 11.3 are instances of inventory meta-classes that specialise Entity, which, in turn, extends class `XCore::Class`, they inherit the ability to

have constraints, attributes and operations (and their associated specialisations, namely, Specifications and EntityAttribute). As an example, the `IPStream_S2000` is associated with `S2000Spec`, which has the following XOCL body:

```
self.upStream = 250 and
self.downStream = 2000 and
self.unitType = "kbps"
```

In addition, XOCL can be used to write operations on the inventory model. XOCL extends OCL with a small number of action primitives, thus turning it into a programming language at the modelling level. As an example, the following operation creates an instance of an `IPStream` and adds it as a `containedServices` attribute to an `IPVPN`:

```
context IPVPN
@Operation addIPStream(up,dwn,unit,con)
  self.containedServices :=
    self.containedService->including(IPStream(up,dwn,unit,con))
end
```

Finally, because the entities in the model are themselves instantiable, it is possible to create an instance of the `IPStreamModel` and check that the instance satisfies the constraints that are defined in the inventory model (see figure 11.4). This is a further level of instantiation that is possible because of the `metaPackage` relationship between the inventory model and the inventory language meta-model. Furthermore, the operations on the model can be executed, allowing all aspects of the model to be validated.

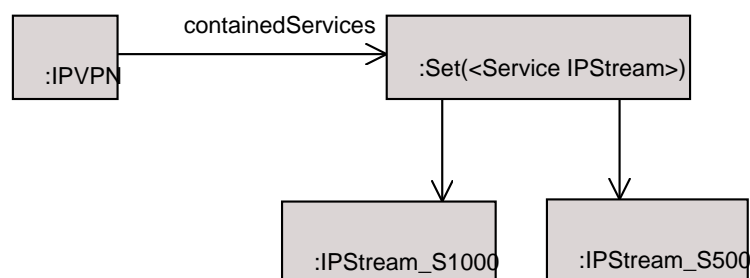

Figure 11.4: A snapshot (instance) of the `IPVPNModel`

11.7 Transformations

Using XMap, two mappings have been defined from the inventory language. The first generates EJBs, while the second focuses on the generation of Java and a Java class tool. We concentrate on the second one here.

The model of figure 11.5 shows the mappings used to generate Java. Rather than mapping directly from the inventory language meta-model, a more generic approach is taken in which the mapping was defined from XCore classes. Because the inventory language extends the XCore meta-model, they therefore also apply to inventory models (and any other language specialisations defined in the future).

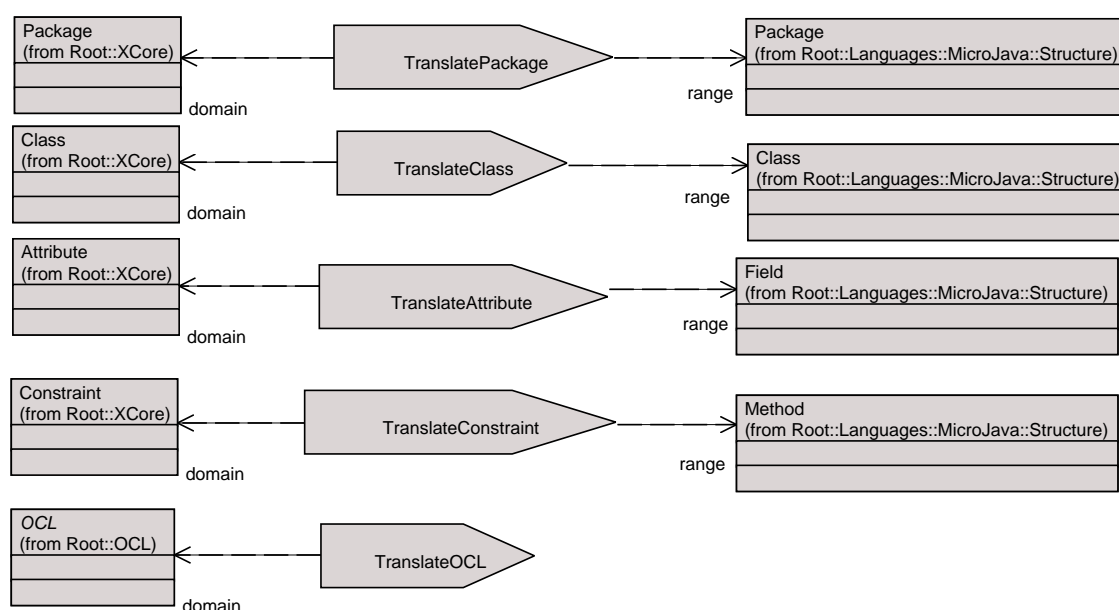

Figure 11.5: Overview of the XCore to Java mapping

Every element in the XCore package has a mapping to a corresponding element in the Java meta-model. The following clause describes a mapping from an XCore class to a Java class:

```

context TranslateClass
  @Clause MapClass
    XCore::Class[name = name,
                  parents = P,
                  operations = O,
                  constraints = C,
                  attributes = A] do
      classToMicroJava(name, P, O, C, A)
    end

```

Here, a Class is mapped to a Java Class, which is the result of passing the class's name, parents, operations, constraints and attributes into the operation `classToMicroJava()`. This operation is shown below:

```

context XCore::Class
@Operation classToMicroJava(name,P,O,C,A)
  let K = constraintsToMicroJava(C);
      M = O->asSeq->collect(o | XCoretoMicroJava(o));
      F = A->asSeq->collect(a | XCoretoMicroJava(a))
  in if P = Set{Object}
      then [| @Java class <name> { <*> F + K + M <*> } end |]
      else
          let parent = P->sel.name.toString()
          in [| @Java class <name> extends <Seq{parent}> { <*> F + K + M
              *> } end |]
          end
      end
  end
end

```

Briefly, the operation makes use of quasi quotes (see chapter 5) to 'drop' the name, parent and (once they have been translated) the attributes, operations and constraints into a syntactical definition of a Java class. This is possible because an XBNF grammar has been defined for the MicroJava language. The result will be an instance of the MicroJava language metamodel, which can then be outputted as a program in textual form.

An important point to make about the mapping is that it translates all elements of an XCore model (and by specialisation and inventory model) into Java. This includes the bodies of operations and constraints, which are translated into Java operations. The resulting Java program can be run and checked against the behaviour of the original model running on the VM.

11.8 Tool Mapping

While the above mapping generates a standalone Java program corresponding to an inventory model, it would be more useful to users of the language if the model it represents could be interacted with via a user interface. To achieve this, a mapping was constructed from XCore to a meta-model of a tool interface for managing object models. This represents a domain specific language for tools. The meta-model of the class tool interface is shown in figure 11.6. A class tool provides an interface that supports a standard collection of operations on objects, such as saving and loading objects and

checking constraints on objects. In addition, a class tool defines a number of managers on classes, which enable instances of classes to be created and then checked against their class's constraints or their operations run.

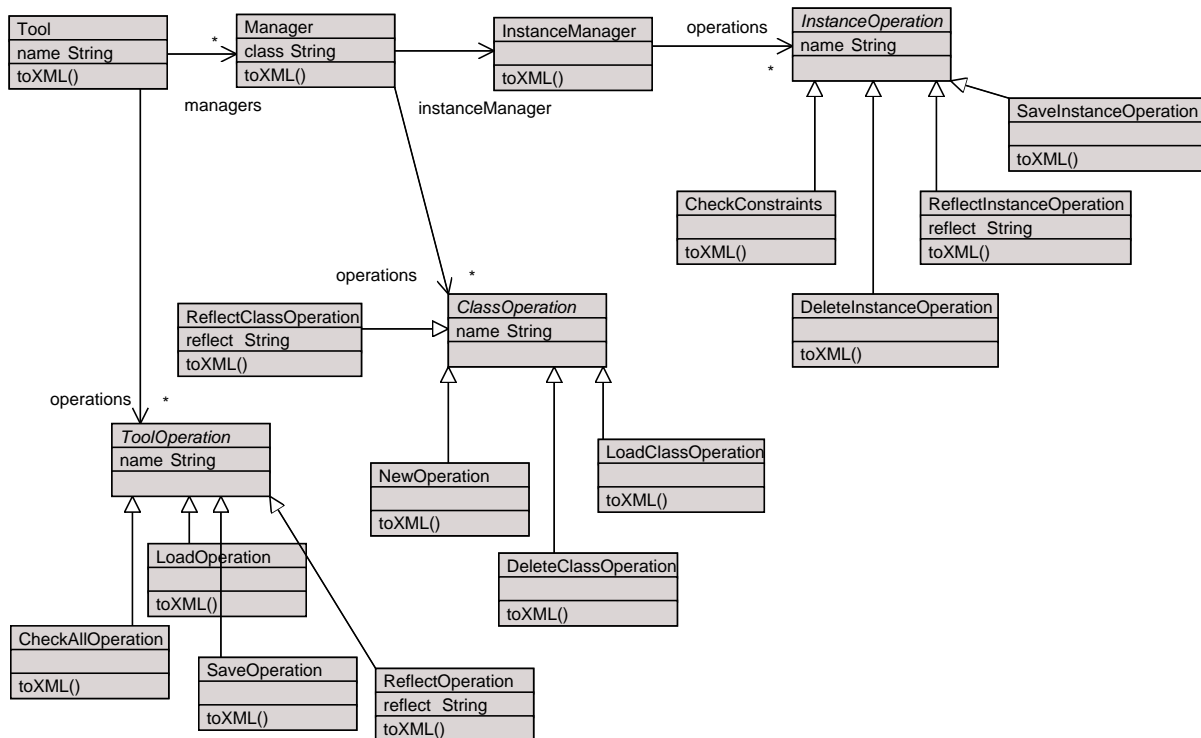

Figure 11.6: The class tool metamodel

A mapping can be defined to the class tool meta-model (not shown here), which generates a tailored user interface for creating and manipulating instances of a meta-modelling language such as the inventory language. Applying this mapping to the IPVPN model shown in figure 11.6 results in the generation of the class tool in figure 11.7. Here, buttons have been generated for each of the entities in the model. These allow the user to create new instances, edit their slot values and delete instances. As the figure shows, a button for invoking the `addIPStream()` method defined earlier has also been added in the GUI executing functionality that implements in Java the method's behaviour described in the model with XOCL.

11.9 Conclusion

This chapter has shown how a relatively light weight approach to extending a meta-model can be used to define a domain specific modelling language. Metapackages were

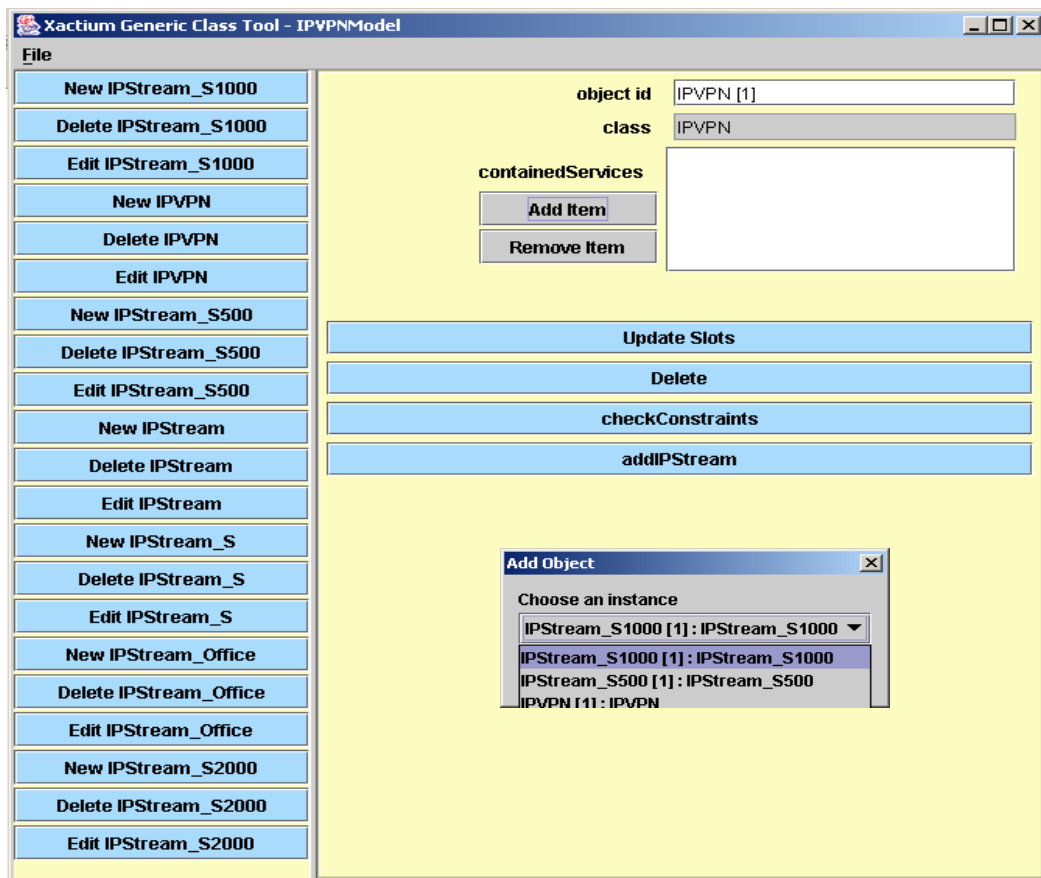

Figure 11.7: The generated class tool

used to ensure consistency of models against its metmodel. Because of the completeness of the new language, it was then possible to generate a complete deployment of domain specific language in Java.

CHAPTER 12

CASE STUDY 3: A SIMPLE PROGRAMMING LANGUAGE

12.1 Introduction

This chapter describes how XMF can be used to define the syntax and semantics of a simple action based programming language called XAction. It begins by presenting the XAction language and then define a concrete grammar for it. Next a variety of approaches, including operational and translational approaches are used to define an executable semantics for the language. Note, this chapter provides an in depth technical treatment of semantics.

12.2 XAction

XAction is a simple action language with values that are either records or are atomic. An atomic data value is a string, integer or boolean. A record is a collection of named values. XAction is block-structured where blocks contain type definitions and value definitions. XAction has simple control structures: conditional statements and loops. The following is a simple example XAction program that builds a list of even numbers from 2 to 100:

```
begin
  type Pair is head tail end
  type Nil is end
  value length is 100 end
  value list is new Nil end
  while length > 0 do
    begin
```

```
if length % 2 = 0
then
  begin
    value pair is new Pair end
    pair.head := length;
    pair.tail := list;
    list := pair;
  end
end;
length := length - 1;
end
end
```

The definition of XAction is structured as a collection of XMF packages. The `Values` package defines the semantic domain for XAction; it contains classes for each type of program value. Executable program phrases in XAction are divided into two categories: `Expressions` and `Statements`. `Expressions` evaluate to produce XAction values. `Statements` are used to control the flow of execution and to update values.

```
@Package XAction
  @Package Values end
  @Package Expressions end
  @Package Statements end
end
```

The rest of this section defines the syntax of XAction by giving the basic class definitions and the XBNF grammar rules for the language constructs.

12.2.1 XAction Values

XAction expressions evaluate to produce XAction values. Values are defined in the `Values` package and which is the *semantic domain* for XAction. Values are either atomic: integers and booleans, or are records. We use a simple representation for records: a sequence of values indexed by names.

XAction records are created by instantiating XAction record types. A record type is a sequence of names. Types raise an interesting design issue: should the types be included as part of the semantic domain since evaluation of certain XAction program phrases give rise to types that are used later in the execution to produce records. The answer to the question involves the phase distinction that occurs between *static* analysis (or execution) and *dynamic* execution. Types are often viewed as occurring only during static analysis; although this is not always the case. We will show how the semantics of XAction can be defined with and without dynamic types.

All values are instances of sub-classes of the class `Value`:

```

context Values
  @Class Value
    @Attribute value : Element end
    @Constructor(value) ! end
  end

```

Atomic values are either booleans or integers. Each class defines operations that the semantic domain provides for manipulating XAction values. The classes below show the structure and a representative sample of operations:

```

context Values
  @Class Bool extends Value
    @Operation binAnd(Bool(b))
      Bool(value and b)
    end
    @Operation binOr(Bool(b))
      Bool(value or b)
    end
  end

```

```

context Values
  @Class Int extends Value
    @Operation binAdd(Int(n))
      Int(value + n)
    end
  end

```

Record types are sequences of names. A type provides a `new` operation that instantiates the type to produce a new record. This operation is only meaningful if we have dynamic types:

```

context Values
  @Class Type extends Value
    @Attribute names : Seq(String) end
    @Constructor(names) ! end
    @Operation new()
      Record(self, names->collect(n | Seq{n | null}))
    end
  end

```

Records are sequences of values indexed by names; the names are found by navigating to the type of the record:

```
context Values
@Class Record extends Value
  @Attribute type : Type end
  @Attribute fields : Seq(Element) end
  @Constructor(type, fields) ! end
  @Operation lookup(name:String)
    fields->at(type.names->indexOf(name))
  end
  @Operation update(name:String, value:Element)
    fields->setAt(type.names->indexOf(name), value)
  end
end
```

12.2.2 XAction Expressions

XAction expressions are program phrases that evaluate to produce XAction values. The following classes define the expression types:

```
context Expressions
@Class Exp
end
end
```

A binary expression has a left and right sub-expression and an operation. The name of the operation is represented as a string:

```
context Expressions
@Class BinExp extends Exp
  @Attribute op : String end
  @Attribute left : Exp end
  @Attribute right : Exp end
  @Constructor(op, left, right) ! end
end
```

An atomic constant expression is either an integer or a boolean:

```

context Expressions
  @Class Const extends Exp
    @Attribute value : Element end
    @Constructor(value) ! end
  end
end

```

A new record is produced by performing a *new* expression. The type to instantiate is given as a string. An alternative representation for types in *new* expressions would be to permit an arbitrary expression that *evaluates* to produce a type. This design choice would rule out static typing and force the language to have dynamic types. We wish to use XAction to illustrate the difference between dynamic and static types in semantic definitions so we use strings to name types in *new* expressions:

```

context Expressions
  @Class New extends Exp
    @Attribute type : String end
    @Constructor(type) ! end
  end
end

```

A variable is just a name:

```

context Expressions
  @Class Var extends Exp
    @Attribute name : String end
    @Constructor(name) ! end
  end

```

A record field ref is:

```

context Expressions
  @Class FieldRef extends Exp
    @Attribute value : Exp end
    @Attribute name : String end
    @Constructor(value,name) ! end
  end

```

The concrete syntax of expressions is defined by the XBNF grammar for the class `Exp`. The grammar parses the expression syntax and synthesizes instances of the expression

classes:

```

context Exp
  @Grammar
  // Start at Exp. Logical operators bind weakest.
  Exp ::= e = ArithExp [ op = LogicalOp l = Exp { BinExp(op,e,l) } ].
  LogicalOp ::= 'and' { "and" } | 'or' { "or" }.
  // The '.' for field ref binds tighter than '+' etc.
  ArithExp ::= e = FieldRef [ op = ArithOp a = FieldRef { BinExp(op,e
    ,a) } ].
  ArithOp ::= '+' { "+" }.
  // A field reference '.' optionally follows an atomic expression.
  FieldRef ::= e = Atom ('.' n = Name { FieldRef(e,n) } | { e }).
  // Atomic expressions can be arbitrary exps if in ( and ).
  Atom ::= Const | Var | New | '(' Exp ')'.
  Const ::= IntConst | BoolConst.
  IntConst ::= i = Int { Const(i) }.
  BoolConst ::= 'true' { Const(true) } | 'false' { Const(false) }.
  Var ::= n = Name { Var(n) }.
  New ::= 'new' n = Name { New(n) }.
end

```

12.2.3 XAction Statements

XAction statements are used to:

- Introduce new names associated with either types or values.
- Control the flow of execution.
- Perform side effects on records.

The following classes define the statement types for XAction:

```

context Statements
  @Class Statement
  end
end

```

A block (as in Pascal or C) contains local definitions. Names introduced in a block are available for the rest of the statements in the block (including sub-blocks) but are not available when control exits from the block:

```

context Statements
  @Class Block extends Statement
    @Attribute statements : Seq(Statement) end
    @Constructor(statements) ! end
  end
end

```

A declaration introduces either a type or a value binding:

```

context Statements
  @Class Declaration isabstract extends Statement
    @Attribute name : String end
  end
end

```

A type declaration associates a type name with a sequence of field names. To keep things simple we don't associate fields with types:

```

context Statements
  @Class TypeDeclaration extends Declaration
    @Attribute names : Seq(String) end
    @Constructor(name,names) ! end
  end
end

```

A value declaration associates a name with a new value. The value is produced by performing an expression at run-time:

```

context Statements
  @Class ValueDeclaration extends Declaration
    @Attribute value : Exp end
    @Constructor(name,value) ! end
  end
end

```

A while statement involves a test and a body:

```

context Statements
  @Class While extends Declaration

```

```
@Attribute test : Exp end
@Attribute body : Statement end
@Constructor(test,body) ! end
end
end
```

An if statement involves a test, a then-part and an else-part:

```
context Statements
@Class If extends Declaration
@Attribute test : Exp end
@Attribute thenPart : Statement end
@Attribute elsePart : Statement end
@Constructor(test,elsePart) ! end
end
end
```

```
context Statements
@Class FieldUpdate extends Declaration
@Attribute record : Exp end
@Attribute name : Exp end
@Attribute value : Exp end
@Constructor(record,name,value) ! end
end
end
```

```
context Statements
@Class Update extends Declaration
@Attribute name : String end
@Attribute value : Exp end
@Constructor(name,value) ! end
end
end
```

```
context Statement
@Grammar extends Exp.grammar
```

```

Statement ::= Block | Declaration | While | If | Update |
           FieldUpdate.
Block ::= 'begin' s = Statement* 'end' { Block(s) }.
Declaration ::= TypeDeclaration | ValueDeclaration.
TypeDeclaration ::= 'type' n = Name 'is' ns = Name* 'end' {
  TypeDeclaration(n,ns) }.
ValueDeclaration ::= 'value' n = Name 'is' e = Exp 'end' {
  ValueDeclaration(n,e) }.
FieldUpdate ::= e = Exp '.' n = Name ':=' v = Exp ';' {
  FieldUpdate(e,n,v) }.
While ::= 'while' e = Exp 'do' s = Statement 'end' {
  While(e,s) }.
If ::= 'if' e = Exp 'then' s1 = Statement 'else' s2 = Statement '
  end' {
  If(e,s1,s2) }.
Update ::= n = Name ':=' e = Exp ';' {
  Update(n,e) }.
end

```

12.3 An Evaluator for XAction

As described in the introduction we are interested in defining XAction operational semantics. We will do this in a number of different ways in the rest of this note. The first, and possibly most straightforward, approach is to define an *interpreter* for XAction in the XOCL language. This involves writing an `eval` operation for each of the XAction syntax classes. The `eval` operation must be parameterized with respect to any context information that is required to perform the evaluation. An XAction program `p` is then evaluated in a context `e` by: `p.eval(e)`.

12.3.1 Evaluating Expressions

Expression evaluation is defined by adding `eval` operations to each class in `Expressions` as follows:

```

context Exp
  @AbstractOp eval(env:Env):Value
end

```

Evaluation of a constant produces the appropriate semantic domain value:

```
context Const
  @Operation eval(env)
  @TypeCase(value)
    Boolean do Bool(value) end
    Integer do Int(value) end
  end
end
```

Evaluation of a variable involves looking up the current value. The value is found in the current context of evaluation: this must contain associations between variable names and their values. This is the only thing required of the XAction evaluation context and therefore we represent the context as an *environment* of variable bindings:

```
context Var
  @Operation eval(env)
  env.lookup(name)
end
```

Evaluation of a binary expression involves evaluation of the sub-expressions and then selecting an operation based on the operation name. The following shows how XAction semantics is completely based on XOCL semantics since + in XAction is performed by + in XOCL.

```
context BinExp
  @Operation eval(env)
  @Case op of
    "and" do left.eval(env).binAnd(right.eval(env)) end
    "or"  do left.eval(env).binOr(right.eval(env))  end
    "+"   do left.eval(env).binAdd(right.eval(env)) end
  end
end
```

Creation of new records is performed by evaluating a new expression. The interpreter has dynamic types so the type to instantiate is found by looking up the type name in the current environment:

```
context New
  @Operation eval(env)
  env.lookup(type).new()
end
```

Field reference is defined as follows:

```
context FieldRef
  @Operation eval(env)
    value.eval(env).lookup(name)
  end
```

12.3.2 Evaluating Statements

XAction statements are performed in order to introduce new names, control flow or to update a record field. Statements are defined to evaluate in a context and must observe the rules of scope that require variables are local to the block that introduces them. The context of execution is an environment; evaluation of a statement may update the supplied environment, so statement evaluation returns an environment:

```
context Statement
  @AbstractOp eval(env):Env
  end
```

A value declaration evaluates the expression part and then extends the supplied environment with a new binding:

```
context ValueDeclaration
  @Operation eval(env)
    env.bind(name, value.eval(env))
  end
```

A type declaration extends the supplied environment with a new type:

```
context TypeDeclaration
  @Operation eval(env)
    env.bind(name, Type(names))
  end
```

A block must preserve the supplied environment when its evaluation is complete. Each statement in the block is performed in turn and may update the current environment:

```
context Block
```

```
@Operation eval(originalEnv)
  let env = originalEnv
  in @For statement in statements do
    env := statement.eval(env)
  end
end;
originalEnv
end
```

A while statement continually performs the body while the test expression returns true. A while body is equivalent to a block; so any updates to the supplied environment that are performed by the while body are discarded on exit:

```
context While
@Operation eval(originalEnv)
  let env = originalEnv
  in @While test.eval(env).value do
    env := body.eval(env)
  end;
  originalEnv
end
end
```

An if statement conditionally performs one of its sub-statements:

```
context If
@Operation eval(env)
  if test.eval(env).value
  then thenPart.eval(env)
  else elsePart.eval(env)
  end
end
end
```

```
context FieldUpdate
@Operation eval(env)
  record.eval(env).update(name,value.eval(env))
end
```

```
context Update
  @Operation eval(env)
  env.update(name, value.eval(env))
end
```

12.4 A Translator for XAction with Run-Time Types

The previous section defines an interpreter for XAction. This is an appealing way to define the operational semantics of a language because the rules of evaluation work directly on the abstract syntax structures. However the resulting interpreter can often be very inefficient. Furthermore, an interpreter can lead to an *evaluation phase distinction*. Suppose that XAction is to be embedded in XOCL. XOCL has its own interpretive mechanism (the XMF VM); at the boundary between XOCL and XAction the XOCL interpretive mechanism must hand over to the XAction interpreter – the XAction code that is performed is a data structure, a completely alien format to the VM. This phase distinction can lead to problems when using standard tools, such as save and load mechanisms, with respect to the new language. For example a mechanism that can save XOCL code to disk cannot be used to save XAction code to disk (it can, however, be used to save the XAction interpreter to disk).

An alternative strategy is to translate the source code of XAction to a language for which we have an efficient implementation. No new interpretive mechanism is required and no phase distinction arises. Translation provides the opportunity for static analysis (since translation is performed prior to executing the program). As we mentioned earlier, static analysis can translate out any type information from XAction programs; the resulting program does not require run-time types. Since static analysis requires a little more work, this section describes a simple translation from XAction to XOCL that results in run-time types; the subsequent section shows how this can be extended to analyse types statically and remove them from the semantic domain.

12.4.1 Translating Expressions

Translation is defined by adding a new operation `desugar1` to each abstract syntax class. There is no static analysis, so the operation does not require any arguments. The result of the operation is a value of type `Performable` which is the type of elements that can be executed by the XMF execution engine.

```
context Exp
  @AbstractOp desugar1():Performable
end
```

An XAction constant is translated to an XOCL constant:

```
context Const
  @Operation desugar1():Performable
  @TypeCase (value)
    Boolean do BoolExp(value) end
    Integer do IntExp(value) end
  end
end
```

An XAction binary expression is translated to an XOCL binary expression. Note that the sub-expressions are also translated:

```
context BinExp
  @Operation desugar1():Performable
  @Case op of
    "and" do [| <left.desugar1()> and <right.desugar1()> |] end
    "or"  do [| <left.desugar1()> and <right.desugar1()> |] end
    "+"   do [| <left.desugar1()> + <right.desugar1()> |] end
  end
end
```

An XAction new expression involves a type name. Types will be bound to the appropriate variable name in the resulting XOCL program; so the result of translation is just a message new sent to the value of the variable whose name is the type name:

```
context New
  @Operation desugar1():Performable
  [| <OCL::Var(type)>.new() |]
end
```

XAction variables are translated to XOCL variables:

```
context Var
  @Operation desugar1():Performable
  OCL::Var(name)
end
```

XAction field references are translated to the appropriate call on a record:

```

context FieldRef
  @Operation desugar1():Performable
  [| <value.desugar1()>.ref(<StrExp(name)>) |]
end

```

12.4.2 Translating Statements

An XAction statement can involve local blocks. The equivalent XOCL expression that provides local definitions is `let`. A `let` expression consists of a name, a value expression and a body expression. Thus, in order to translate an XAction declaration to an XOCL `let` we need to be passed the body of the `let`. This leads to a translational style for XAction actions called *continuation passing* where each `desugar1` operation is supplied with the XOCL action that will be performed next:

```

context Statement
  @AbstractOp desugar1(next:Performable):Performable
end

```

A type declaration is translated to a local definition for the type name. Note that the expression `names.lift()` translates the sequence of names to an expression that, when performed, produces the same sequence of names: `list` is a means of performing evaluation in reverse:

```

context TypeDeclaration
  @Operation desugar1(next:Performable):Performable
  [| let <name> = Type(<names.lift()>)
    in <next>
    end
  |]
end

```

A value declaration is translated to a local definition:

```

context ValueDeclaration
  @Operation desugar1(next:Performable):Performable
  [| let <name> = <value.desugar1()>
    in <next>
    end
  |]

```

end

A block requires each sub-statement to be translated in turn. Continuation passing allows us to chain together the sequence of statements and nest the local definitions appropriately. The following auxiliary operation is used to implement block-translation:

```
context Statements
@Operation desugar1 (statements, next: Performable) : Performable
  @Case statements of
    Seq{} do
      next
    end
    Seq{statement | statements} do
      statement.desugar1 (Statements::desugar1 (statements, next))
    end
  end
end
```

Translation of a block requires that the XOCL local definitions are kept local. Therefore, the sub-statements are translated by chaining them together and with a final continuation of `null`. Placing the result in sequence with `next` ensures that any definitions are local to the block.

```
context Block
@Operation desugar1 (next: Performable) : Performable
  [| <Statements::desugar1 (statements, [| null |])> ;
    <next>
  |]
end
```

A while statement is translated to the equivalent expression in XOCL:

```
context While
@Operation desugar1 (next: Performable) : Performable
  [| @While <test.desugar1 ()>.value do
    <body.desugar1 ( [| null |])>
    end;
    <next>
  |]
end
```

An `if` statement is translated to an equivalent expression in XOCL:

context If

```
@Operation desugar1(next:Performable):Performable
  [| if <test.desugar1()>.value
    then <thenPart.desugar1(next)>
    else <elsePart.desugar1(next)>
    end
  |]
end
```

context FieldUpdate

```
@Operation desugar1(next:Performable):Performable
  [| <record.desugar1()>.update(<StrExp(name)>, <value.desugar1()>);
    <next>
  |]
end
```

context Update

```
@Operation desugar1(next:Performable):Performable
  [| <name> := <value.desugar1()>;
    <next>
  |]
end
```

12.5 A Translator for XAction without Run-Time Types

It is usual for languages to have a static (or *compile time*) phase and a dynamic (or *run time*) phase. Many operational features of the language can be performed statically. This includes type analysis: checking that types are defined before they are used and allocating appropriate structures when instances of types are created. This section shows how the translator for XAction to XOCL from the previous section can be modified so that type analysis is performed and so that types do not occur at run-time.

12.5.1 Translating Expressions

Since types will no longer occur at run-time we will simplify the semantic domain slightly and represent records as *a-lists*. An a-list is a sequence of pairs, the first element of each pair is a ket and the second element is a value. In this case a record is an a-list where the keys are field name strings. XOCL provides operations defined on sequences that are to be used as a-lists: $l \rightarrow \text{lookup}(\text{key})$ and $l \rightarrow \text{set}(\text{key}, \text{value})$.

The context for static analysis is a type environment. Types now occur at translation time instead of run-time therefore that portion of the run-time context that would contain associations between type names and types occurs during translation:

```

context Exp
  @AbstractOp desugar2 (typeEnv:Env) :Performable
end

```

Translation of a constant is as for `desugar1`:

```

context Const
  @Operation desugar2 (typeEnv:Env) :Performable
  self.desugar1 ()
end

```

Translation of binary expressions is as for `desugar1` except that all translation is performed by `desugar2`:

```

context BinExp
  @Operation desugar2 (typeEnv:Env) :Performable
  @Case op of
    "and" do [| <left.desugar2 (typeEnv)> and
              <right.desugar2 (typeEnv)> |] end
    "or"  do [| <left.desugar2 (typeEnv)> and
              <right.desugar2 (typeEnv)> |] end
    "+"   do [| <left.desugar2 (typeEnv)> +
              <right.desugar2 (typeEnv)> |] end
  end
end

```

Translation of a variable is as before:

```

context Var
  @Operation desugar2 (typeEnv:Env) :Performable

```

```

    self.desugar1()
end

```

A `new` expression involves a reference to a type name. The types occur at translation time and therefore part of the evaluation of `new` can occur during translation. The type should occur in the supplied type environment; the type contains the sequence of field names. The result of translation is an XOCL expression that constructs an a-list based on the names of the fields in the type. The initial value for each field is `null`:

```

context New
@Operation desugar2(typeEnv:Env):Performable
  if typeEnv.binds(type)
  then
    let type = typeEnv.lookup(type)
    in type.names->iterate(name exp = [| Seq{} |] |
      [| <exp>->bind(<StrExp(name)>,null) |])
    end
  else self.error("Unknown type " + type)
  end
end

```

A field reference expression is translated to an a-list lookup expression:

```

context FieldRef
@Operation desugar2(typeEnv:Env):Performable
  [| <value.desugar2(typeEnv)>->lookup(<StrExp(name)>) |]
end

```

12.5.2 Translating Statements

A statement may contain a local type definition. We have already discussed continuation passing with respect to `desugar1` where the context for translation includes the next XOCL expression to perform. The `desugar2` operation cannot be supplied with the next XOCL expression because this will depend on whether or not the current statement extends the type environment. Therefore, in `desugar2` the continuation is an operation that is awaiting a type environment and produces the next XOCL expression:

```

context Statement
@AbstractOp desugar2(typeExp:Env,next:Operation):Performable

```

end

A type declaration binds the type at translation time and supplies the extended type environment to the continuation:

```
context TypeDeclaration
  @Operation desugar2 (typeEnv:Env, next:Operation) :Performable
    next (typeEnv.bind (name, Type (names) ) )
end
```

A value declaration introduces a new local definition; the body is created by supplying the unchanged type environment to the continuation:

```
context ValueDeclaration
  @Operation desugar2 (typeEnv:Env, next:Operation) :Performable
    [| let <name> = <value.desugar2 (typeEnv)>
      in <next (typeEnv)>
      end
    |]
end
```

Translation of a block involves translation of a sequence of sub-statements. The following auxiliary operation ensures that the continuations are chained together correctly:

```
context Statements
  @Operation desugar2 (statements,typeEnv, next) :Performable
    @Case statements of
      Seq{} do
        next (typeEnv)
      end
      Seq{statement | statements} do
        statement.desugar2 (
          typeEnv,
          @Operation (typeEnv)
            Statements::desugar2 (statements,typeEnv, next)
          end)
      end
    end
end
end
```

A block is translated to a sequence of statements where local definitions are implemented using nested `let` expressions in XOCL. The locality of the definitions is maintained by sequencing the block statements and the continuation expression:

```

context Block
  @Operation desugar2 (typeEnv:Env, next:Operation) :Performable
  [| <Statements::desugar2 (
    statements,
    typeEnv,
    @Operation(ignore)
    [| null |]
    end) >;
  <next (typeEnv) >
  |]
end

```

A while statement is translated so that the XOCL expression is in sequence with the expression produced by the continuation:

```

context While
  @Operation desugar2 (typeEnv:Env, next:Operation) :Performable
  [| @While <test.desugar2 (typeEnv) >.value do
    <body.desugar2 (typeEnv, @Operation (typeEnv) [| null |] end) >
    end;
  <next (typeEnv) >
  end
  |]
end

```

The `if` statement is translated to an equivalent XOCL expression:

```

context If
  @Operation desugar2 (typeEnv:Env, next:Operation) :Performable
  [| if <test.desugar2 (typeEnv) >.value
    then <thenPart.desugar2 (typeEnv, next) >
    else <elsePart.desugar2 (typeEnv, next) >
    end
  |]
end

```

```
context FieldUpdate
  @Operation desugar2 (typeEnv:Env, next:Operation) :Performable
  [| <record.desugar2 (typeEnv)>.update (
    <StrExp (name)>,
    <value.desugar2 (typeEnv)>);
    <next (typeEnv)>
  |]
end
```

```
context Update
  @Operation desugar2 (typeEnv:Env, next:Operation) :Performable
  [| <name> := <value.desugar2 (typeEnv)>;
    <next (typeEnv)>
  |]
end
```

12.6 Compiling XAction

The previous section shows how to perform static type analysis while translating XAction to XOCL. XOCL is then translated to XMF VM instructions by the XOCL compiler (another translation process). The result is that XAction cannot do anything that XOCL cannot do. Whilst this is not a serious restriction, there may be times where a new language wishes to translate directly to the XMF VM without going through an existing XMF language. This may be in order to produce highly efficient code, or because the language has some unusual control constructs that XOCL does not support. This section shows how XAction can be translated directly to XMF VM instructions.

12.6.1 Compiling Expressions

```
context Exp
  @AbstractOp compile (typeEnv:Env, valueEnv:Seq (String)) :Seq (Instr)
end
```

```
context Const
  @Operation compile (typeEnv, valueEnv)
```



```
@TypeCase (value)
  Boolean do
    if value
      then Seq{PushTrue()}
      else Seq{PushFalse()}
    end
  end
  Integer do
    Seq{PushInteger(value)}
  end
end
end
```

```
context Var
@Operation compile(typeEnv,valueEnv)
  let index = valueEnv->indexOf(name)
  in if index < 0
    then self.error("Unbound variable " + name)
    else Seq{LocalRef(index)}
  end
end
end
```

```
context BinExp
@Operation compile(typeEnv,valueEnv):Seq(Instr)
  left.compile(typeEnv,valueEnv) +
  right.compile(typeEnv,valueEnv) +
  @Case op of
    "and" do Seq{And()} end
    "or"  do Seq{Or()} end
    "+"   do Seq{Add()} end
  end
end
end
```

```
context New
@Operation compile(typeEnv,valueEnv):Seq(Instr)
  self.desugar2(typeEnv).compile()
end
```

```
context FieldRef
  @Operation compile(typeEnv,valueEnv):Seq(Instr)
    Seq{StartCall(),
        PushStr(name)}
    value.compile(typeExp,valueExp) +
    Seq{Send("lookup",1)}
end
```

12.6.2 Compiling Statements

```
context Statement
  @AbstractOp compile(typeEnv:Env,varEnv:Seq(String),next:Operation):
    Seq(Instr)
end
```

```
context TypeDeclaration
  @Operation compile(typeEnv,varEnv,next)
    next(typeEnv.bind(name,Type(names)),varEnv)
end
```

```
context ValueDeclaration
  @Operation compile(typeEnv,varEnv,next)
    value.compile(typeEnv,varEnv) +
    Seq{SetLocal(name,varEnv->size),
        Pop()} +
    next(typeEnv,varEnv + Seq{name})
end
```

```
context Statements
  @Operation compile(statements,typeEnv,varEnv,next)
    @Case statements of
      Seq{} do
        next(typeEnv,varEnv)
end
```

```

Seq{statement | statements} do
  statement.compile(
    typeEnv,
    varEnv,
    @Operation(typeEnv, varEnv)
      Statements::compile(statements, typeEnv, varEnv, next)
    end)
  end
end
end

```

```

context Block
  @Operation compile(typeEnv, varEnv, next)
  Statements::compile(
    statements,
    typeEnv,
    varEnv,
    @Operation(localTypeEnv, localVarEnv)
      next(typeEnv, varEnv)
    end)
  end

```

```

context While
  @Operation compile(typeEnv, varEnv, next)
  Seq{Noop("START")} +
  test.compile(typeEnv, varEnv) +
  Seq{SkipFalse("END")} +
  body.compile(typeEnv, varEnv,
    @Operation(typeEnv, varEnv)
      Seq{}
    end) +
  Seq{Skip("START")} +
  Seq{Noop("END")} +
  next(typeEnv, varEnv)
  end

```

```

context If
  @Operation compile(typeEnv, varEnv, next)

```

```
test.compile(typeEnv, varEnv) +
Seq{SkipFalse("ELSE")} +
thenPart.compile(typeEnv, varEnv,
  @Operation(typeEnv, varEnv)
  Seq{Skip("END")}
  end) +
Seq{Noop("ELSE")} +
elsePart.compile(typeEnv, varEnv,
  @Operation(typeEnv, varEnv)
  Seq{Skip("END")}
  end) +
Seq{Noop("END")} +
next(typeEnv, varEnv)
end
```

12.7 Abstract Syntax to Concrete Syntax

We have shown how XAction is translated from concrete syntax to abstract syntax by defining an XBNF grammar. It is often useful to be able to translate in the opposite direction and produce concrete syntax from abstract syntax. This can be done with or without formatting. The latter is useful only when the concrete syntax is to be consumed by a machine or when it can be supplied to a pretty-printing tool.

Formatting of code can be performed in fairly sophisticated ways, for example allowing the width of the page to be supplied as a parameter to the formatter. This section shows how a simple code formatter for XAction can be defined by attaching `pprint` operations to the abstract syntax classes.

An expression is formatted by supplying it with an output channel, it is assumed that the channel is in the correct output column:

```
@AbstractOp pprint(out:OutputChannel) end
```

A variable is pretty-printed by printing its name:

```
context Var
@Operation pprint(out)
  format(out, "~S", Seq{name})
end
```

A constant is pretty-printed by printing its value:

```

context Const
  @Operation pprint(out)
    format(out, "~S", Seq{value})
  end

```

A new expression prepends the type with the keyword:

```

context New
  @Operation pprint(out)
    format(out, "new ~S", Seq{type})
  end

```

A binary expression pretty-prints the left sub-expression, the operator name and then the right sub-expression:

```

context BinExp
  @Operation pprint(out)
    left.pprint(out);
    format(out, " ~S ", Seq{op});
    right.pprint(out)
  end

```

A statement is pretty-printed by supplying it with the output channel and the current level of indentation. The indentation controls how many tab-stops must be output after each newline. This is necessary because statements can be nested and indentation is used to visualise the level of nesting.

```

context Statement
  @AbstractOp pprint(out:OutputChannel, indent:Integer) end

```

A block is pretty-printed by incrementing the indentation for each nested statement:

```

context Block
  @Operation pprint(out, indent)
    format(out, "begin");
    @For s in statements do
      format(out, "%~V", Seq{indent + 2});
      s.pprint(out, indent + 2)
    end;

```

```
format(out, "%~Vend", Seq(indent))  
end
```

An if statement is pretty-printed as follows:

context If

```
@Operation pprint(out, indent)  
format(out, "if ");  
test.pprint(out);  
format(out, "%~Vthen~V", Seq(indent, indent + 2));  
thenPart.pprint(out, indent+2);  
format(out, "%~Velse~V", Seq(indent, indent + 2));  
elsePart.pprint(out, indent+2);  
format(out, "%~Vend", Seq(indent))  
end
```

A type declaration is pretty-printed as follows, note the use of { to iterate through the sequence of field names in the format control string:

context TypeDeclaration

```
@Operation pprint(out, indent)  
format(out, "type ~S is {, ~; ~S~} end", Seq(name, names))  
end
```

A value declaration:

context ValueDeclaration

```
@Operation pprint(out, indent)  
format(out, "value ~S is ", Seq(name));  
value.pprint(out);  
format(out, " end")  
end
```

A while statement:

context While

```
@Operation pprint(out, indent)  
format(out, "while ");  
test.pprint(out);  
format(out, " do~%~V", Seq(indent+2));
```

```
body.pprint(out,indent+2);  
format(out,"~%~Vend",Seq{indent})  
end
```

12.8 Conclusion

This chapter has shown how XMF can be used to define the operational semantics of languages. We have shown how to implement an interpreter for a simple language and how to translate the language to existing XMF languages. We have discussed a number of different issues relating to language translation, in particular how much work is performed statically and how much is left to run-time.

CHAPTER 13

CASE STUDY 4: INTERACTIVE TV

13.1 Introduction

An increasing number of interactive applications can be downloaded onto devices such as mobile phones, PDAs, web-browsers and TV set-top boxes. The applications involve presenting the user with information, options, menus and buttons. The user typically enters information by typing text and choosing amongst alternatives. An event is generated by the user clicking a button or selecting from a menu. Once an event is generated an engine that services the interactive application processes the event, updates its internal state and then produces a new dialog to present to the user.

The dialogs required by the interactive applications tend to be fairly simple and are often used in conjunction with other applications such as being broadcast together with TV video and audio content. The technology used to construct the interactive application should be accessible to as broad a spectrum of users as possible, including users whose primary skill is not in developing interactive software applications.

Technologies used for interactive displays include Java-based technologies such as the Multimedia Home Platform (MHP)[MHP08] , HTML and JavaScript. These technologies are very platform specific. They include a great deal of technical detail and are certainly not approachable by a non-specialist. Furthermore, the general low-level nature of the technologies does not enforce any standard look-and-feel to interactive applications. The applications developed for a given client (for example a single TV company) should have a common look and feel that is difficult to enforce at such a low-level.

A common way to abstract from technical detail and to enforce a common look-and-feel for a suite of applications is to develop a *domain-specific language* (DSL) whose concepts match the expectations and skill-levels of the intended users. A DSL for interactive applications will include constructs for expressing textual content, buttons and choices. The DSL leaves the rendering of the display features and the event generation to a dis-

play engine that enforces a given look-and-feel. The display engine can be replaced, changing the look-and-feel without changing the DSL.

In addition to the DSL supporting high-level features for expressing display content, it must provide some means for describing what the application *does*. Normally, application processing algorithms are expressed at a low-level in program-code. If the DSL is designed with an *execution engine* then the same approach to abstraction from rendering detail can be applied to abstraction from the operational detail.

An executable DSL is a language for expressing complete applications without detailed knowledge of implementation technologies. The xDSL is a modelling language, instances of which are expressed as data. An execution engine processes the data and runs the application. The xDSL engine can be embedded within devices and other software applications in order to run the models.

This chapter describes the design of an xDSL for interactive applications. The xDSL has a textual syntax and is implemented in the tool XMF [XMF08]. XMF is a platform for developing DSL-based applications. It provides an extensive high-level language called XOCL for developing applications and XOCL can be extended with new language constructs. The design of XMF has been based on Common Lisp [Lis08], Smalltalk, Scheme [Sch08] and ObjVLisp [Coi87]. The DSL for interactive applications described in this chapter can be developed on any platform, but XMF is ideally suited to the task.

The rest of this chapter is structured as follows: section 13.2 describes an architecture for interactive applications based on an xDSL; section 13.3 describes the xDSL from the point of view of the application developer, it outlines the language features in terms of a simple application involving a quiz; section 13.4 describes how the xDSL is implemented on XMF; section 13.5 shows how the rendering engine can be simulated and connected to the xDSL engine to simulate the execution of an interactive application; section 13.6 shows how the application models can be serialized as XML; section 13.7 concludes by reviewing the key features of the approach and the technology used to develop the xDSL engine.

13.2 Interactive Application Architecture

Figure 13.1 shows an overview of the architecture for an interactive application xDSL. XMF is used as the DSL implementation engine. XMF provides facilities for developing text-based modelling languages and their associated execution engines. The xDSL is written as a model in XMF, the applications are then loaded onto the xDSL engine and executed.

The application generates display information in a general-purpose format; in this case XML. The XML display information is sent to a rendering engine. The engine understands the display features of the DSL and interprets them in terms of the rendering technology. This achieves a separation of concerns whereby the DSL can focus on the information content and execution logic whereas the rendering engine can focus on a standard way of displaying the information without necessarily having to understand

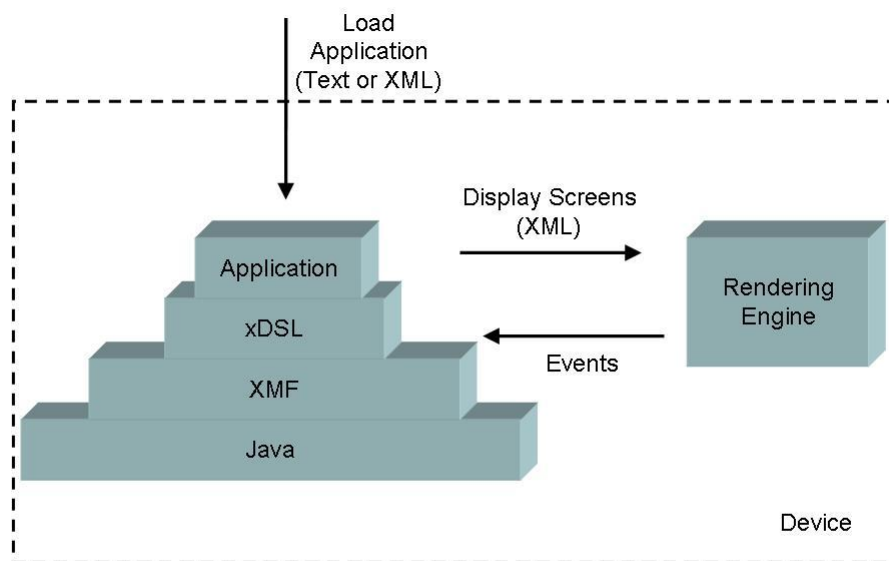

Figure 13.1: Application Architecture

anything about the application that is being rendered.

The rendering engine controls the hardware that interacts with the user. The user generates events that are sent back to the xDSL engine. In principle the events can be very detailed and can be encoded in a suitable DSL. The example presented in this chapter uses a very simple encoding of events.

When the xDSL receives an event, it must process the data in an appropriate way to produce more display information for the rendering engine. The processing information is expressed in the application model running on the xDSL engine. The display/event loop continues until the application is terminated.

The architecture shown in figure 13.1 has been used a number of times based on the XMF processing engine. The development environment XMF-Mosaic is completely based upon a number of rendering engines based on various features of Eclipse: browsers, property editors and diagram editors. The architecture has also been successfully used where XMF is deployed as a web-application and the rendering engine is a standard web-browser (using various combinations of HTML and the Google Web Toolkit).

13.3 A DSL for Interactive Applications

This section presents a simple interactive application expressed using the xDSL and then shows it running. The following section shows how the xDSL is implemented in XMF.

Textual languages are developed in XMF by extending the basic language with new language features. XMF has a small basic language; the rest is developed by extension. Each new language feature starts with an '@' character; the feature may be used wherever any normal language construct is expected. In this way, the XMF engine can be developed into any special purpose DSL engine.

The following fragment shows the start of an interactive application:

```
@Model Quiz
  // The Quiz model describes an interactive application
  // for a TV quiz. Viewers are presented with a sequence
  // of questions and get a final score...
  score : Integer;
  // Screen definitions...
end
```

Each model consists of a collection of screens. Each screen describes how it is to be rendered and how it responds to events. For example, the following screen starts the application. It places some text above a button named Start. When the engine receives a Start event then the application makes a transition to the screen named Question1:

```
screen START()
  vertical
    text Welcome to the Quiz. Click the button to Start end
    button Start
      go Question1()
    end
  end
end
```

Options are offered using a construct that lists the options (how they are displayed is up to the rendering engine). The option group is named; the name is used to refer to the particular option value that the user selects when the event returns to the xDSL engine. This is a typical way of encoding variable information during dialogs: http does this and can be used to determine the values of fields and choices on HTML screens. The first part of the Question1 screen uses options as shown below:

```
screen Question1()
  vertical
    text What is the capital of England? end
    options Choice
      option London;
      option Paris;
      option Madrid;
    end
    // Question1 continues...
```

Layout can be handled using many sophisticated schemes. A useful, simple way to specify layout is to use horizontal and vertical flow, where these can be nested. The options are displayed below the text in the fragment given above. In the fragment below, the buttons for Next and Quit are displayed next to each other (but below the options):

```

// ... Question1 continues...
horizontal
  button Next
    // Next action continues...
  end
  button Quit
    go Quit()
  end
end
end
end
end

```

The Next event is received after the user has chosen an option. If the option is correct then the user is congratulated and the score is incremented, otherwise the user is told the correct answer. In both cases the dialog continues with the next question.

Actions may be conditional, the conditional expression may refer to choice variables, values of variables passed to screens and the current state of the model instance. Actions may also produce displays (without having to go to a new screen) which allows variables to be scoped locally within an action¹. In the following, the Next action has two local displays that are used to respond to the choice:

```

// ...Next action continues...
if Choice = "London"
then
  display
    text Well Done end
    button Next
      score := score + 1;
      go Question2()
    end
  end
else
  display
    text Wrong! Answer is London. end
    button Next

```

¹We really should have a let-construct and some local variables here to show that the nested display has access to locally-scoped variables over a user-transaction.

```

        go Question2()
    end
end
end

```

The DSL is simple and closely matches the concepts required to define an interactive application. It could be extended in a variety of ways, for example pattern matching event data and further display concepts. It includes execution by encoding event handlers. It deals with complexity by being simple and supporting nesting with local scope and modularity. A non-expert in interactive software applications should have no problems writing an application in this DSL.

The following shows a partial execution of this application. Since there is no rendering engine attached, the XML is printed and the responses encoded by hand:

```

<Screen>
  <Vertical>
    <Text text=' Welcome to the Quiz. Click the button to Start '/>
    <Button name=' Start' />
  </Vertical>
</Screen>
Start          <-- Event from rendering engine
<Screen>
  <Vertical>
    <Text text=' What is the capital of England? '/>
    <Options name='Choice' >
      <Option name='London' />
      <Option name='Paris' />
      <Option name='Madrid' />
    </Options>
    <Horizontal>
      <Button name='Next' />
      <Button name='Quit' />
    </Horizontal>
  </Vertical>
</Screen>
Next Choice=London  <-- Event from rendering engine
<Screen>
  <Text text=' Well Done '/>
  <Button name='Next' />
</Screen>
Next          <-- Event from rendering engine

```

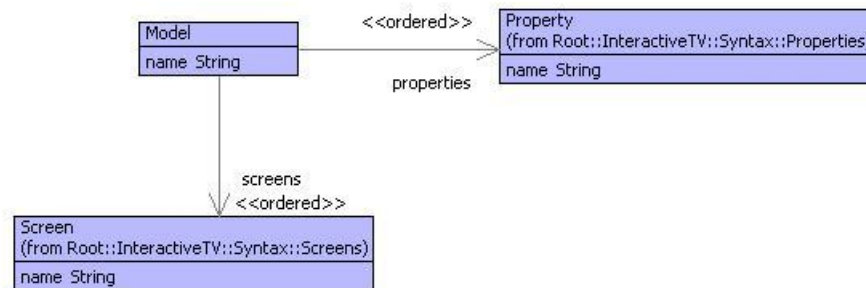

Figure 13.2: Interactive Models

13.4 Implementation

The implementation of the xDSL has two main components: a syntax model and a grammar that transforms text to instances of the syntax model, and a semantics model that defines an execution engine. The syntax model defines a modeling language that defines an application *type*; an instance of the type is defined by the semantics model. This is a typical way to define a language: models represent things that can be *performed* in some sense. Performing the models produces instances whose behaviour is expressed by the model. Another way to think about this is that we aim to produce libraries of reusable interactive applications (instances of the syntax model). A run-time occurrence of an application is described by the semantic model.

XMF provides facilities for working with text including grammars, XML parsers and XML formatters. The models have been developed using the XMF development engine XMF-Mosaic and then run on the basic engine.

13.4.1 Syntax

The syntax for the DSL has two parts: the abstract syntax and the concrete syntax. The abstract syntax consists of a collection of models that are described below. The concrete syntax is defined by a collection of grammars that are defined at the end of this section.

Figure 13.2 shows the top-level model for the interactive application language. A model consists of a collection of properties and a collection of screens. Each property is defined by the model in figure 13.3; it has a name and a classifier. XMF has a meta-model that provides features such as Class and Object. A type is called a Classifier in XMF; Integer, String, Set(Object) are all XMF classifiers.

Screens are shown in figure 13.4. A screen has a collection of arguments. An action may cause the application to make a transition to a screen in which case the transition can supply argument values to be used when calculating the display for the screen. Figure 13.5 shows the model for displays. Each element of the display model can produce

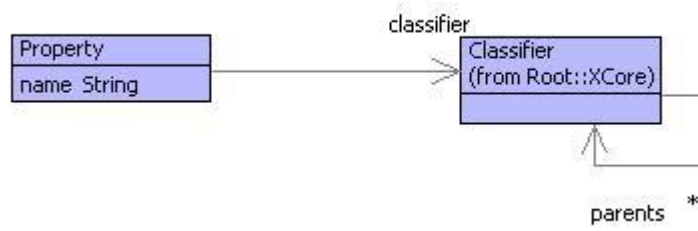

Figure 13.3: Properties

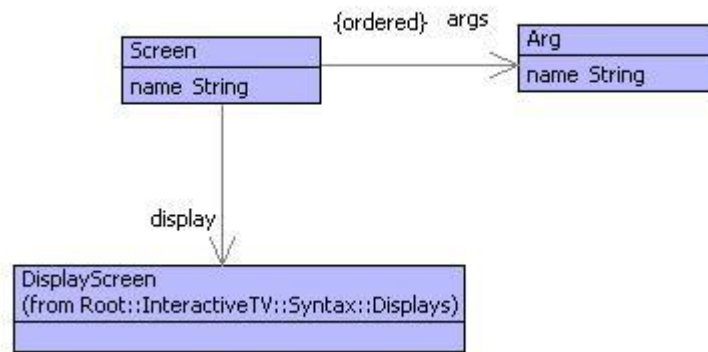

Figure 13.4: Screens

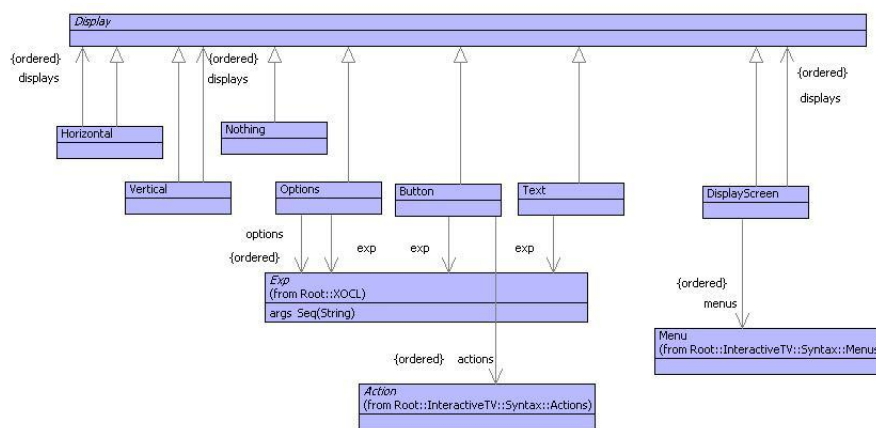

Figure 13.5: Displays

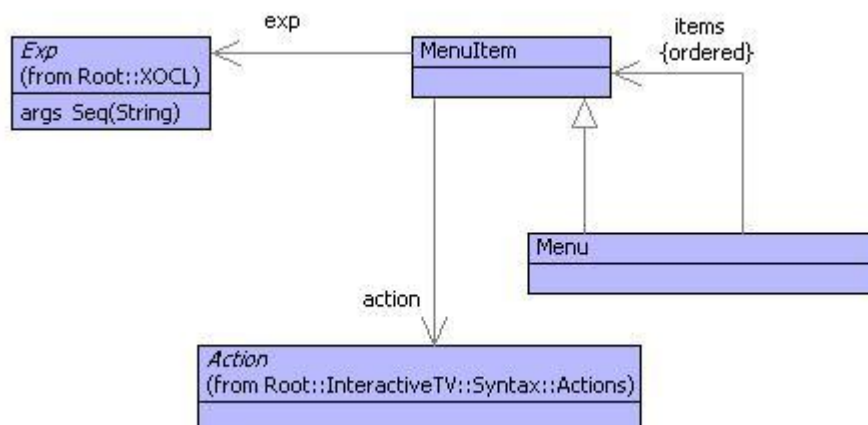

Figure 13.6: Menus

XML output that is understood by the rendering engine. In addition, some of the display elements are associated with actions that will be performed when the appropriate event is received by the xDSL engine.

The display elements of an application model refer to an XOCL class called *Exp*. This is used wherever an executable fragment of code is required. It allows features of the displays to be computed dynamically. For example when a transition to a screen is made, the names of the buttons may depend on the values of the arguments that are passed to the screen. This is the reason why a button has an *exp*: it is used to calculate the label on the button in terms of the variables that are in scope at the time². The *Exp* class is a way of importing the models for XMF expressions into the displays model.

Menus are shown in figure 13.6. Each menu has a label that is computed (again depending on the context) and an action. Actions are defined in figure 13.7. An action is either a transition to a new screen (*Go*), a conditional action (*If*), an update to a variable currently in scope (*Update*) or a local display.

The developer of an interactive application does not directly create instances of the abstract syntax model. The idea is that they write in a text language that is parsed to synthesize instances of the syntax model³.

XMF allows any class to be extended with a grammar. The class then defines a new syntax construct that is completely integrated into the base language of XMF. Any number of classes can be added in this way and new syntax classes can build on existing syntax classes. The following is a simple example of a class definition that implements a simple guarded expression:

²Unfortunately no examples of this feature are given in the document. However, imagine a list of voting options that will depend on the current state of the system.

³Another way of doing this is to use some form of graphical notation. XMF is designed to interface to EMF [emf08] and GMF [gmf08] and therefore provide execution engines for EMF models.

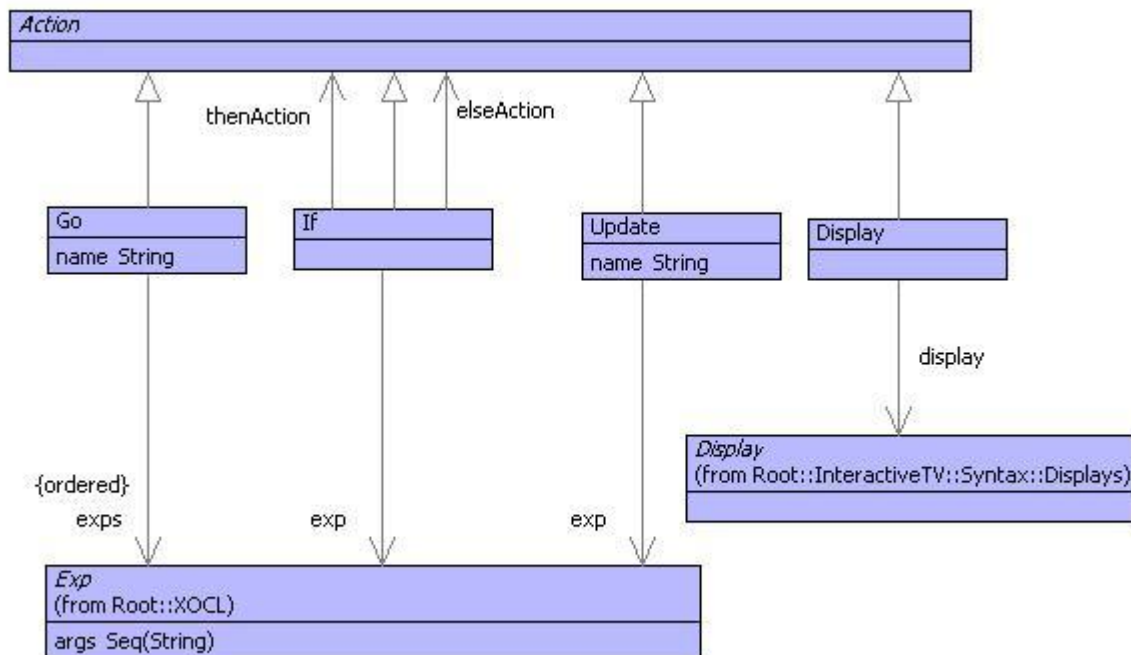

Figure 13.7: Actions

```

@NotNull [e1] .m(e2,e3,e4)
  else e5
end
  
```

where $e1$ evaluates to produce an object to which we want to send the message m with args $e2, e3$ and $e4$. However, $e1$ might produce null in which case we don't want to send the message, we want to do $e5$ instead. This language construct is implemented as follows in XMF:

```

@Class NotNull extends Sugar

@Attribute exp      : String      end
@Attribute name    : String      end
@Attribute isMessage : Boolean    end
@Attribute args    : Seq(Performable) end
@Attribute error   : Performable end

@Constructor(exp,name,error) end

@Constructor(exp,name,args,error)
  self.isMessage := true
end

@Grammar extends OCL.grammar
  NotNull ::=
    '[' e = Exp ']' '.' n = Name NotNullTail^(e,n) 'end'.

  NotNullTail(e,n) ::=
    '(' as = NotNullArgs ')' x = NotNullElse { NotNull(e,n,as,x) }
    | x = NotNullElse { NotNull(e,n,x) }.

  NotNullArgs ::=
    e = Exp es = (',' Exp)* { Seq{e|es} }
    | { Seq{} }.

  NotNullElse ::=
    'else' Exp
    | { [| null |] }.

end

@Operation desugar():Performable
  [| let notNullValue = <exp>
    in if notNullValue = null
      then <error>
      else <if isMessage
        then Send([| notNullValue |],name,args)
        else [| notNullValue.<name> |]
        end>
      end
    end
  [|
end
end

```

end

The key features of the NotNull class are as follows:

- The class extends Sugar which means that it is defining a new syntax construct by providing an operation called 'desugar' whose responsibility is to turn an instance of NotNull into program code.
- The grammar definition extends the OCL grammar and thereby imports all of the basic grammar-rule definitions. This provides the rule for Exp which is the top-level grammar-rule for all language constructs.
- Each grammar-rule consists of a name and a body. The rule may optionally have arguments. The body consists of terminals (in ' and '), builtins such as Name, rule-calls (possibly with arguments) and actions (inside { and }). The rule actions are any program expression, in most cases they use class-constructors to create an instance of a named class.
- The desugar operation uses lifting-quotes ([— and —]) to create an instance of syntax-classes. The opposite of *lifting* is *dropping* (¡ and ¿) used to calculate syntax by evaluating a program expression.

The rest of this section describes how the grammar feature of XMF can be used to define the interaction language. A model consists of a name followed by properties and screen definitions:

```
context Model
  @Grammar extends Property.grammar, Screen.grammar
  Model ::= n = Name ps = Property* ss = Screen* 'end' {
    Model(n, ps, ss)
  }.
end
```

A property is a name and a simple expression (that cannot include the ';' operator). The property-rule action uses an interesting feature of syntax classes that allows the expression to be dropped into the syntax element and is thereby evaluated to produce a classifier for the property type:

```
context Property extends OCL::OCL.grammar
  @Grammar extends OCL.grammar
  Property ::= n = Name ':' e = SimpleExp ';' {
    Property(n, Drop(e))
  }.
end
```

end

A screen has a name, arguments, menus and display elements. The rule for screen arguments shows how optional elements are processed: it returns either a non-empty sequence of names $\text{Seq}\{a\text{---}as\}$ (head followed by tail) or the empty sequence $\text{Seq}\{\}$:

```
context Screen
@Grammar extends Menu.grammar, Display.grammar
Screen ::=
  'screen' n = Name '(' as = ScreenArgs ')'
    ms = Menu*
    ds = Display*
  'end' { Screen(n,as,DisplayScreen(ms,ds)) }.
ScreenArgs ::=
  a = Name as = (',' Name)* { Seq{a|as} }
  | { Seq{} }.
end
```

A menu is shown below. This shows how expressions are captured in data. The rule for a menu item name returns an instance of the class `Exp` that is used in data to wrap an evaluable expression. There are two forms of construction for `Exp`: `Exp(e)` and `Exp(e,V,null)`. In both cases `e` is an instance of a syntax class. In the second case `V` is a collection of variable names that occur freely in `e`. The values of variables in `V` can be supplied when the expression is evaluated (via `keyApply` as shown below).

Another interesting feature of the menu item name rule is the use of 'lift' to transform a data element (in this case a string `n`) into an expression whose evaluation produces the original data element:

```
context Menu
@Grammar extends OCL.grammar
Menu ::= 'menu' n = MenuItemName is = MenuItem* 'end' {
  Menu(n,is)
}.
MenuItemName ::=
  n = Name { Exp(n.lift()) }
  | e = SimpleExp { Exp(e,e.FV(),null) }.
MenuItem ::=
  Menu
  | 'item' n = MenuItemName a = Action 'end' { MenuItem(n,a) }.
end
```

Since Display is an abstract class, the grammar-rule for Display is a list of concrete alternatives:

```
context Display
@Grammar extends Action.grammar, OCL.grammar
Display ::=
    Text
    | Button
    | Options
    | Horizontal
    | Vertical.
Text ::= 'text' t = Char* 'end' {
    Text(Exp(t.asString().lift()))
}.
Button ::=
    'button' n = ComputedName
    as = Action*
    'end' { Button(n,as) }.
ComputedName ::=
    n = Name { Exp(n.lift()) }
    | e = SimpleExp { Exp(e,e.FV(),null) }.
Options ::=
    'options' n = ComputedName
    os = Option*
    'end' { Options(n,os) }.
Option ::=
    'option' n = Name ';' { n }.
Horizontal ::=
    'horizontal'
    ds = Display*
    'end' { Horizontal(ds) }.
Vertical ::=
    'vertical'
    ds = Display*
    'end' { Vertical(ds) }.
end
```

Action is another example of an abstract class:

```

contxt Action
@Grammar extends OCL.grammar
  Action ::=
    UpdateProperty
  | IfAction
  | Go
  | DisplayScreen.
  DisplayScreen ::=
    'display'
      ms = Menu*
      ds = Display*
    'end' { DisplayScreen(ms,ds) }.
  UpdateProperty ::=
    n = Name ':= ' e = SimpleExp ';' {
      Update(n,Exp(e,e.FV()),null)
    }.
  Go ::= 'go' n = Name '(' as = GoArgs ')' { Go(n,as) }.
  GoArgs ::=
    e = GoArg es = (',' GoArg)* { Seq{e|es} }
  | { Seq{} }.
  GoArg ::= e = SimpleExp { Exp(e) }.
  IfAction ::=
    'if' e = SimpleExp
    'then' d = Action
    IfActionTail^(e,d).
  IfActionTail(e,d1) ::=
    'else' d2 = Action 'end' { If(Exp(e,e.FV()),d1,d2) }
  | 'end' { If(Exp(e,e.FV()),d1,null) }.
end

```

13.4.2 Semantics

The semantics of the interactive application modelling language defines an instance model for the syntax and also defines an execution engine for the instances. The instance model is shown in figure 13.8. An instance of a Model is defined by the class Instance. It should have a slot for each property of the model. The value of each slot should have a type that is defined by the classifier of the corresponding property.

The class Engine defines the execution engine. An engine controls an instance and maintains an id-table that maps event ids to handlers as shown below. The idea is that each time an event occurs, a handler from the id-table is used to produce a new

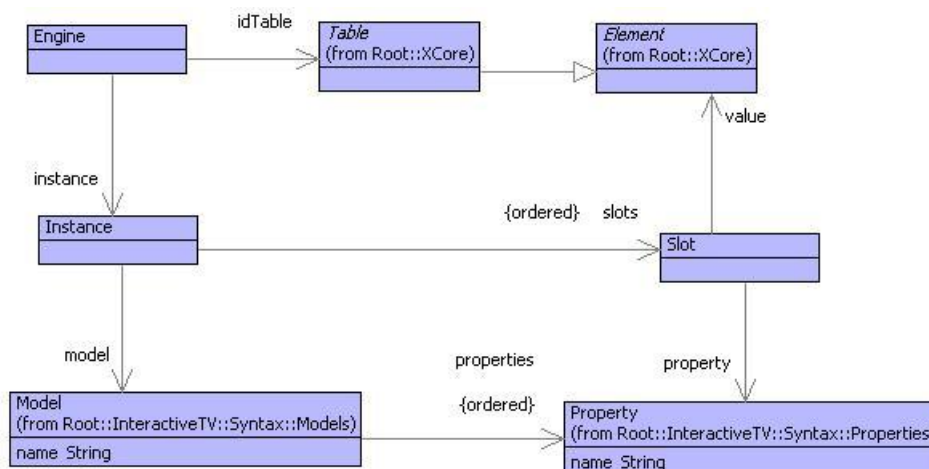

Figure 13.8: Semantics Model

XML display that is sent to the rendering engine. The XML data is calculated from the information in the model and the current state of the instance slots.

The rest of this section defines the engine execution semantics. The following section shows how the engine is connected to a rendering engine. The engine processes a screen-transition using the 'go' operation defined below. XMF supports many types of input and output channel. The 'go' operation shows an example of a string output channel used to capture and then return the XML output data as a string:

```

context Engine
  @Operation go(screen:String, args:Seq(Element))
    let sout = StringOutputChannel()
    in instance.go(screen, args, self, sout);
    sout.getString()
  end
end

```

An instance handles a screen-transition by looking up the screen in its model. If the screen exists then it is requested to display itself with the supplied argument values:

```

context Instance
  @Operation go(screen:String, args:Seq(Element), engine:Engine, out:
    OutputChannel)
  @NotNull [model.indexScreensByName(screen, null)].display(self, args
    , engine, out)

```

```

    else self.error("No screen called " + screen)
  end
end

```

A screen delegates the 'display' message to its underlying display component. The screen argument names are bound to the argument values to produce an *environment of bindings* using the 'env' operation:

```

context Screen
  @Operation display(instance, args, engine, out)
    display.display(instance, self.env(instance, args), engine, out)
  end
context Screen
  @Operation env(instance, values)
    let env = args.zip(values)
    in instance.slots()->iterate(slot env = env |
      env.bind(slot.property().name(), slot.value()))
    end
  end
end

```

Each display element type : Button; Text; Horizontal; Vertical; and, Options implements a 'display' operation that writes XML data to the supplied output channel. As a side effect, if any of the elements have event handling actions then the engine is updated with an appropriate handler for the event when it is received from the rendering engine.

Each 'display' operation shows the use of an XMF language feature @XML ... end that is used to write XML output to a channel. The construct has the form:

```

@XML(out)
<TAG ATTS>
  .. program code ...
</TAG>
end

```

where the literal XML data is written to the supplied output channel. In-between writing the starting tag and ending tag, an arbitrary program is processed.

```

context DisplayScreen
  @Operation display(instance, env, engine, out)
    @XML(out)
    <Screen>

```

```

    @For menu in menus do
      menu.display(instance,env,engine,out)
    end
    @For display in displays do
      display.display(instance,env,engine,out)
    end
  </Screen>
end
end

```

The 'display' operation for text shows an example of the shortened form of the XML construct with no body, and also the use of the 'keyApply' operation of the Exp class. The 'env' argument supplied to 'display' contains bindings for all variables in scope. The 'keyApply' operation performs the expression in the context of these variables:

```

context Text
  @Operation display(instance,env,engine,out)
  @XML(out)
  <"Text" text=exp.keyApply(env) />
  end
end

```

A button contains an action that is used to handle the event arising from the user pressing the button in the rendering engine. The 'display' operation for Button shows how an event handler is registered in the engine. The arguments passed to 'registerActions' are the context required to perform the actions when the event associated with 'id' is received:

```

context Button
  @Operation display(instance,env,engine,out)
  let id = exp.keyApply(env)
  in engine.registerActions(id,instance,env,actions);
  @XML(out)
  <Button name=id/>
  end
end
end

```

Horizontal and Vertical are similar:

```

context Horizontal

```

```
@Operation display(instance,env,engine,out)
  @XML(out)
  <Horizontal>
    @For display in displays do
      display.display(instance,env,engine,out)
    end
  </Horizontal>
end
end
```

The 'display' operation for Options shows an example of interleaving of XML and program code:

```

context Options
  @Operation display(instance, env, engine, out)
    @XML(out)
    <Options name=exp.keyApply(env)>
      @For option in options do
        @XML(out)
        <Option name=option/>
      end
    end
  </Options>
end
end

```

The 'registerActions' operation of Engine must define a handler for an event. The definition associates the event identifier 'id' with an operation in the id-table of the engine. Actions are performed using their 'perform' operation which expects to receive arguments that include the current environment of variable bindings. The variables available to an action include all those bound by selecting options on the display. These display-bound variables are supplied to the handler (in the same way that http works) as an environment 'env2':

```

contxt Engine
  @Operation registerActions(id, instance, env1, actions)
    idTable.put(id,
      @Operation(env2)
        let value = null
        in @For action in actions do
          value := action.perform(instance, env2 + env1, self)
        end;
        value
      end
    end)
end

```

There are four types of action: If; Update; Go; and, Display. Each action produces a result and the last action performed should return an XML string to be sent to the rendering engine. It performs one of two actions (or nothing) depending on the outcome of a test:

context If

```

@Operation perform(instance, env, engine)
  if exp.keyApply(env + instance.env())
  then thenAction.perform(instance, env, engine)
  else @NotNull [elseAction].perform(instance, env, engine) end
  end
end

```

An update changes the value of a variable currently in scope. The variables in scope are: the slots of the instance; the current screen arguments. The following operation checks whether the named variable is a slot and updates the instance appropriately, or updates the current environment:

context Update

```

@Operation perform(instance, env, engine)
  @NotNull [instance.getSlot(name)].setValue(exp.keyApply(env +
    instance.env()))
  else env.set(name, exp.keyApply(env + instance.env()))
  end
end

```

Go makes a transition to a new screen. The screen will produce the XML output. Notice that the current 'env' is not supplied to the 'go' operation; therefore any variables currently in scope are not available to the target screen unless their values are passed as arguments:

context Go

```

@Operation perform(instance, env, engine)
  engine.go(name, exp->collect(exp | exp.keyApply(env)))
end

```

Display is a way of locally displaying a screen without losing the variables that are currently in scope:

context Display

```

@Operation perform(instance, env, engine)
  let sout = StringOutputChannel()
  in display.perform(instance, env, engine, sout);
  sout.getString()
end

```

end

13.4.3 Handling Events

Events occur when the user interacts with the rendering engine, for example by pressing a button. When the event occurs, the current screen may contain any number of option groups. Each option group is named and offers a number of alternative values. The selected option may affect the behaviour of the engine in terms of variable updates and screen transitions. Therefore, the event sent from the rendering engine to the xDSL engine must encode the value of any option variables currently displayed.

In addition there may be any number of ways an event can be raised: menu selection or button press. Each must be uniquely identified and the event must supply the identifier of the event that occurred.

An event is defined to have a format that starts with the event id and is followed by any number of option variable/value pairs:

```
<ID> <VAR>=<VALUE> ... <VAR>=<VALUE>
```

The event is encoded as a string and must be decoded by the engine. This is easily done by defining an event as a grammar-rule:

```
context Engine
  @Grammar
  Event ::= n = Name e = Binding* { Seq{n|e} }.
  Binding ::= n = Name '=' v = Name { Seq{n|v} }.
end
```

When an event is received by the engine it is supplied to 'getDisplay' which calculates a new XML display string for the rendering engine. The operation uses the grammar defined above to synthesize a pair `Seq{id—env}` containing the event id and an environment of option-group variable bindings. If the id is bound in the id-table then the handler is supplied with the environment:

```
context Engine
  @Operation getDisplay(event:String)
  let pair = Engine.grammar.parseString(event,"Event",Seq{}) then
    id = pair->head;
    env = pair->tail
  in @TableGet handler = idTable[id] do
```

```
        idTable.clear();
        handler(env)
    else self.error("No handler for " + name)
    end
end
end
end
```

13.5 Simulation

Figure 13.1 shows the architecture of an interactive application. The rendering engine is external to the design of an xDSL; the relationship between the two is defined by the XML schema for the display language and the format of event strings. However, it is useful to be able to simulate the rendering engine in order to test the xDSL engine. This can be done by setting up a simple test harness for a pair of data consumers and linking the xDSL engine with a rendering engine simulation that reads events strings in from the terminal.

The following class implements a data producer-consumer pair:

```
@Class Consumer

  @Attribute filter : Operation end
  @Attribute other  : Consumer (!) end

  @Constructor(filter) ! end

  @Operation consume(data)
    other.consume(filter(data))
  end
end
```

The filter operation is used to generate data that is supplied to the other consumer. If a pair of Consumer instances are linked together then the data will bounce back and forth as required. The following operation creates a filter for the xDSL engine:

```
@Operation mk_xDSL_filter(model:Model)
  let engine = Engine(model.new())
  in @Operation(event)
    engine.getDisplay(event)
  end
end
```

The following filter operation simulates the rendering engine. It does so by pretty-printing the XML to the standard-output. An XML string can be transformed into an XML tree using the 'asXML' operation defined for String. The standard-input is flushed and a line containing the event is read and returned:

```
@Operation renderFilter(xml:String)
  xml.asXML().pprint(stdout);
  "".println();
  stdin.skipWhiteSpace();
  stdin.readLine().stripTrailingWhiteSpace()
end
```

Given a model 'model', the following code produces, and starts, a simulation:

```

@Operation simulate(model:Model)
  let eConsumer = Consumer(mk_xDSL_filter(model));
    dConsumer = Consumer(renderFilter)
  in eConsumer.setOther(dConsumer);
    dConsumer.setOther(eConsumer);
    eConsumer.consume("START")
  end
end

```

13.6 XML Representation for Applications

A requirement for interactive applications is to be able to dynamically update the content and to be able to transfer the content from remote locations in a standard format. The application describes in this chapter is completely represented in data. This means that, although the application is executable, it can easily be serialized, sent over a communications link, and then uploaded onto the device that is running the xDSL engine.

XMF provides support for encoding any data elements as XML. There is a basic markup provided for all XMF data; the mechanisms for which can easily be extended to provide bespoke XML encoding. Using the basic mechanisms, a model can be encoded as follows:

```

@WithOpenFile(fout -> "c:/model.xml")
  let xout = XMLOutputChannel(fout,NameSpaceXMLFormatter())
  in xout.writeValue(model)
  end
end

```

The resulting output is produced in an XML file that is shown in figure 13.9. The XML markup shown in the figure is the default vanilla-flavour markup provided by XMF. It is possible to add adapters to an XML output channel that filter the data as it is processed and thereby use domain-specific markup. So instead of seeing Object and Slot as element tags, we might use Screen and Button.

The XML can be read back in using the following code:

```

@WithOpenFile(fin <- ModelFile)
  let xin = XMLInputChannel(fin,NameSpaceXMLInflater())
  in xin.parse()
  end
end

```

```

- <Object id="0" path="Root::InteractiveTV::Syntax::Models::Model" name="S:4;Quiz">
- <Slot name="properties">
- <List id="1">
- <Object id="2" path="Root::InteractiveTV::Syntax::Properties::Property" name="S:5;score">
- <Slot name="classifier">
  <Namespace path="Root::XCore::Integer" />
</Slot>
</Object>
</List>
</Slot>
- <Slot name="screens">
- <List id="3">
- <Object id="4" path="Root::InteractiveTV::Syntax::Screens::Screen" name="S:5;START">
- <Slot name="display">
- <Object id="5" path="Root::InteractiveTV::Syntax::Displays::DisplayScreen">
- <Slot name="displays">
- <List id="6">
- <Object id="7" path="Root::InteractiveTV::Syntax::Displays::Vertical">
- <Slot name="displays">
- <List id="8">
- <Object id="9" path="Root::InteractiveTV::Syntax::Displays::Text">
- <Slot name="exp">
- <Object id="10" path="Root::XOCL::Exp" args="O:">
- <Slot name="op">
- <Fun name="" id="11" arity="0" isVarArgs="false"
  sig="K:K:I:2;K:K:S:5;XCoreK:S:7;ElementO:O:O:" doc=""
  imports="K:S:8;Root::IOK:S:30;Root::InteractiveTV::SemanticsK:S:19;Root::InteractiveTVK:
- <CodeBox id="12" name="" locals="0"
  resource="c:/modelling/interactivetv/test.xml"
  binary="26,0,28,0,28,0" source="@Operation
  ()XCore::Element " Welcome to the Quiz. Click the

```

Figure 13.9: A Serialized Model

13.7 Conclusion

This chapter has described an approach to modelling systems whereby an engine for an executable domain-specific language (xDSL) is used to develop and run the applications. The xDSL is designed to use concepts that are suited to the application domain which allows the language to abstract away from implementation details; the language is then executable, can be used with different implementation platform technologies, and is suitable for use by people whose primary skill lies in the application domain rather than the implementation technology.

A method for developing xDSLs has been shown that involves a separation of concerns between syntax elements that describe type-level features of a model, and semantics elements that define run-time features of an application. Experience has shown that this separation is natural and allows the xDSL developer to effectively manage the process.

We have shown how a textual syntax can be added to an xDSL. In practice, most xDSLs will require a concrete syntax. The precise form of this will depend on the nature of the application and who the intended users are. Sometimes, a purely graphical syntax is appropriate (for example UML class-diagrams). Other times a purely textual syntax works best, especially where executable features are involved and when complexity can be controlled effectively using textual nesting. Often there is scope for a mixture of the two where different aspects of the models are constructed using graphical or textual syntax.

Modelling all features of a language has a number of benefits that arise because everything is *reified*. Reification involves representing everything as data as opposed to program code or transient non-tangible artifacts such as system events. Once everything is reified, many types of analysis are possible including well-formedness checking, type checking, application of style rules. It becomes easy to capture and apply patterns and to perform refactoring. All features of an application can be transformed to a target technology.

Modelling actions is particularly important here; often actions are left as unprocessed strings of program code which makes it very difficult to analyze and run as part of an xDSL engine. The application given in this paper has shown that it is straightforward to model actions and to integrate them into the execution engine for an xDSL. By following a few basic guidelines in terms of variable scope and control flow, actions are easy to implement and are completely integrated into the xDSL, its analysis and transformation.

The approach models the xDSL and executes it directly using an engine (in this case XMF). This is attractive because it provides a high degree of control over the language. It should be contrasted with a translational approach to implementing a DSL whereby the model is translated to the source code of a target language (such as Java or C++) for which there is an implementation platform. This is an approach taken by Swul [SWU08] and GMF [gmf08] for GUI applications. Translational approaches have some advantages: notably open architectures; efficiency; arbitrary extensibility. However, there are some significant disadvantages relating to the complexity of the generated

code including maintainability and understandability. It should be noted that an xDSL engine-based approach does not preclude a translational approach.

We have given a complete implementation of an interactive application xDSL using the features of XMF. XMF is an engine that is specifically designed to support this kind of application development. It has very high-level language features that support modelling concepts, it is executable, and is designed to support textual language extension through the use of extensible grammars. XMF directly supports textual xDSLs and provides native interfaces to Java and EMF/GMF for use with other concrete syntaxes.

XMF may be used to develop an xDSL and then deploy the language as a stand-alone engine as shown in figure 13.1. XMF runs its own virtual machine and has a number of interface features that allow it to connect to external applications. XMF may also be used to develop an executable design of an application which is then exported on to another implementation platform.

CHAPTER 14

CASE STUDY 5: GRAPHS

14.1 Introduction

Unfortunately, information is not always conveniently organised in a tree structure. A tree structure does not make allowances for relationships that span the tree or where cycles occur in the data. For example, what happens when a company employee fills two roles within the company in different departments? It would be appropriate for the employee to occur underneath both departments in the tree; the employee is *shared* between the departments or equivalently there are two different *paths* from the root of the tree to the employee.

Trees do not represent sharing and multiple paths very well. There are strategies; for example, XML is a tree structured data format where labels are used to mark up the elements in order to represent sharing. When data representation requires sharing, it is usually because the data naturally forms a *graph*. Graphs can be encoded in trees (and other forms of data representation), but if the data requires a graph then it is probably best to use one and be done with it.

14.2 A Model of Graphs

Figure 14.1 shows a model of graphs. A graph consists of a set of nodes and a set of edges. Each node has a label and a sequence of data. The label is used to identify the node and the data is used by applications for whatever purpose they require.

Each edge has a label and data, and also has a source and target node. Edges go between nodes and are directed. The diagram shown in figure 14.1 is itself an example of a graph where the nodes are displayed as class boxes and the edges are shown as attribute edges. Notice that the node labelled Element is shared (parent-wise) between Edge and Node; equivalently there are two paths from the root node (labelled Graph)

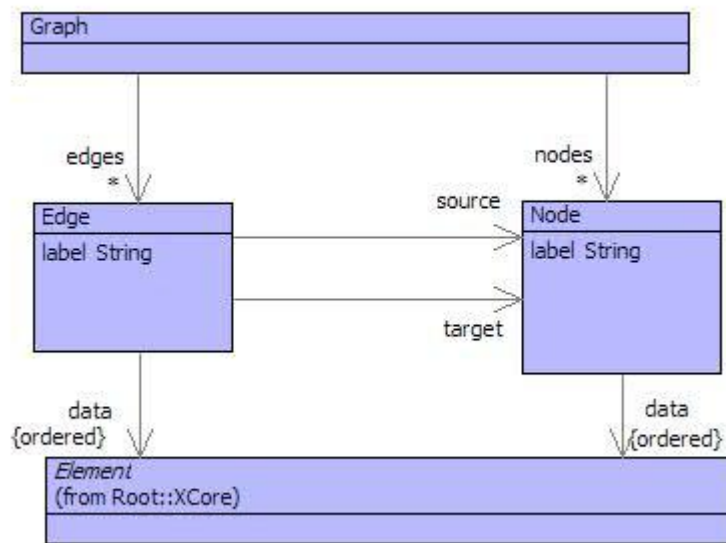

Figure 14.1: Graphs

to the node labelled Element: Graph, Edge, Element and Graph, Node, Element. Such sharing is difficult to represent using trees.

Graphs are a very rich form of data representation. There is a wealth of material written about graphs and how to process them. Here are some useful operations on graphs defined in XOCL:

```

context Graph
  @Operation nodeFor(label:String):Node
  @Find(node,nodes)
    when node.label() = label
    else null
  end
end
  
```

The operation `nodeFor` returns the node with the supplied label, or null if no such node exists. The operation `edgesFrom` returns the set of edges from a given node:

```

context Graph
  @Operation edgesFrom(n:Node):Set(Edge)
  edges->select(e | e.source() = n)
end
  
```

Graphs are generally useful and therefore it is appropriate to have a general purpose language construct to define a graph. As mentioned above, each use of a graph structure will attach different amounts of data to the nodes and labels. The data is used to support the application specific processing of the graph. Therefore, a general purpose language construct for graph construction should support:

1. Arbitrary node and edge data.
2. Plug-points for the sub-classes of Graph, Node and Edge that are used to represent the graph.

14.3 Graph Applications

Here are two examples of different graph applications:

```
@Graph(Routes, Location, Road)
```

```
London()
```

```
  M1(200) -> Leeds
```

```
  A1(50)  -> Cambridge
```

```
end
```

```
@Graph(Plan, Task, Dependency)
```

```
Start("January")
```

```
  -> Contractors
```

```
  -> Plans
```

```
Contractors("March")
```

```
Plans("April")
```

```
end
```

The first graph is represented as an instance of the class Routes where the nodes and edges are instances of the classes Location and Road. These classes are sub-classes of Graph, Node and Edge respectively. Locations have no data; the three locations have labels London, Leeds and Cambridge.

An edge is listed below the source node. In the first example graph, there are two edges with labels M1 and A1. The edges have data 100 and 50 (being the distance in miles) and the label of the edge target is given after *-j*.

The second example is a plan graph. The nodes have data that represents the month at which the task is completed. Edges have no labels or data (they just represent dependencies).

The proposed structure for a graph definition has plug-points for the graph, node and edge classes and a body consisting of a sequence of node definitions. A node definition *n* is a node label, followed by node data in parentheses followed by a series of edge

definitions for which the source of the node is n . An edge definition is an optional edge label, optional edge data in parentheses, an arrow and then the label of the target node. Here is an example:

```
@Graph(G,N,E)
  n1(a,b,c)
    e1(d) -> n2
    e2() -> n3
  n2()
    e3() -> n1
  n3()
```

When the parser encounters a graph definition it will synthesize program code that, when evaluated, produces the required graph. Are there any rules that need to be observed when this synthesis takes place? Given the model of graphs in figure 14.1, a graph contains nodes and edges, and edges link nodes. Here is a possible program that produces the graph above

```
(1) let g = G()
(2) in g.addToNodes(N("n1",Seq{a,b,c}));
      g.addToNodes(N("n2"));
(3)   g.addToNodes(N("n3"));
(4)   g.addToEdges(E("e1",Seq{d},g.nodeFor("n1"),g.nodeFor("n2")));
      g.addToEdges(E("e2",g.nodeFor("n1"),g.nodeFor("n3")));
(5)   g.addToEdges(E("e3",g.nodeFor("n2"),g.nodeFor("n1")));
(6)   g
      end
```

Line (1) creates the graph using the supplied class G (a sub-class of $Graph$). Each node must be added first in lines (2-3) so that edges can then be created *between* the nodes in lines (4-5). Note that the supplied classes N and E are used to create the nodes and edges. Finally the graph is returned in line (6).

The rules for graph construction are: create the graph, add the nodes and then add the edges. Unfortunately, the graph definition construct does not follow this pattern; it interleaves node and edge definitions. A strategy is required to untangle this interleaving.

One way to address the interleaving is to have the parser synthesize an intermediate graph definition that is processed using two or more passes. This is perfectly respectable, and often a sensible way forward when the required processing is fairly complex.

In this case, the processing is not that complex, so another strategy is used. To see how this works, a few definitions are required. An *edge constructor* expects a graph and

an edge class; it adds some edges to the supplied graph. A *node constructor* expects a graph, a node class, an edge class and a collection of edge constructors; it adds some nodes to the supplied graph and then uses the edge constructor to add some edges.

Node definitions are synthesized into node constructors and edge definitions into edge constructors. The trick is to build up the edge constructors so that they are performed after all the node constructors. Since the edge constructors are supplied to the node constructors, this should be easy. Using the running example from above:

```
n3 =
  @Operation(nodeConstructor)
  @Operation(g,N,E,edgeConstructor)
    g.addToNodes(N("n3"));
    nodeConstructor(g,N,E,edgeConstructor)
  end
end
```

The node definition for n3 is transformed into an operation that is supplied with a node constructor and returns a node constructor. This construction allows n3 to be linked with other node constructors without knowing any details – i.e. n3 can be defined *in isolation*.

The node constructor for n2 is similar, but involves the addition of an edge constructor:

```
n2 =
  @Operation(nodeConstructor)
  @Operation(g,N,E,edgeConstructor)
    let e3 =
      @Operation(g,E)
        g.addToEdges(E("e3",g.nodeFor("n2"),g.nodeFor("n1")))
      end
    in g.addToNodes(N("n2"));
      nodeConstructor(g,N,E,addEdges(edgeConstructor,e3))
    end
  end
end
```

Note how the edge constructor for e3 is added to the supplied edge constructor (using the yet-to-be-defined `addEdges`) when the supplied node constructor is activated. This is the key to deferring the construction of edges until all the nodes have been defined.

What should `addEdges` do? It is used to link all the edge constructors together so that they all get activated. It takes two edge constructors and returns an edge constructor:

```

@Operation addEdges(ec1,ec2)
  @Operation(g,E)
    ec1(g,E);
    ec2(g,E)
  end
end

```

The noe constructor for n1 is similar, but two edge constructors are required:

```

n1 =
  @Operation(nodeConstructor)
    @Operation(g,N,E,edgeConstructor)
      let e1 =
        @Operation(g,E)
          g.addToEdges(E("e1",g.nodeFor("n1") Seq{d},g.nodeFor("n2")))
        end;
        e2 =
          @Operation(g,E)
            g.addToEdges(E("e1",g.nodeFor("n1"),g.nodeFor("n3")))
          end then
            edges = addEdges(e1,e2)
          in g.addToNodes(N("n2"));
            nodeConstructor(g,N,E,addEdges(edgeConstructor,edges))
          end
        end
      end
    end
  end

```

The complete graph can now be defined by linking the node constructors together and supplying a graph:

```

let nc = addNodes(n1,addNodes(n2,addNodes(n3,noNodes)))
in nc(G(),N,E,@Operation(g,E) g end)
end

```

Each of the node constructors are linked via an operation addNodes. The left-hand argument of addNodes is an operation that maps a node constructor to a node constructor. The right-hand argument is a node constructor. It is easier to see how this works from the definition:

```

@Operation addNodes(nodeCnstrCnstr,nodeCnstr2)

```

```

@Operation (g, N, E, edgeConstructor)
  let nodeCnstr1 = nodeCnstrCnstr (nodeCnstr2)
  in nodeCnstr1 (g, N, E, edgeConstructor)
  end
end
end

```

The mechanism used by `addNodes` is an example of a typical pattern that threads sequences of operations together. It allows the node constructor encoded in `nodeCnstrCnstr` to occur before that encoded in `nodeCnstr2` while also allowing the edge constructors produced by the first to be handed on to the second (because they are to be deferred until all the nodes are added to the graph).

There are two types of constructor, each of which can occur repeatedly in a sequence: nodes and edges. When this occurs, it is usual to have some way to encode an empty sequence; in this case there are `noNodes` and `noEdges`. Both of these are constructors:

```

@Operation noNodes (g, N, E, edgeConstructor)
  edgeConstructor (g, E)
end

@Operation noEdges (g, E)
  null
end

```

`noNodes` is a node constructor that starts edge construction. Therefore, `noNodes` should be the right-most node constructor in a sequence that is combined using `addNodes`. `noEdges` does nothing, and can occur anywhere in a sequence.

The grammar for graph definition synthesizes node and edge constructors combined using `addNodes` and `addEdge`. When an empty sequence is encountered, the grammar synthesizes `noNodes` and `noEdges` respectively. The grammar is defined below:

```

@Grammar extends OCL::OCL.grammar
  Data ::= '(' es = CommaSepExps ')' { SetExp("Seq", es) }.
  Edges(s) ::= e = Edge^(s) es = Edges^(s)
    { [| addEdges(<e>, <es>) |] }
  | { [| noEdges |] }.
  Edge(s) ::= l = Label d = OptData '->' t = Label { [|
    @Operation (g, E)
      g.addToEdges (E (<l>, <d>, g.nodeFor (<s>), g.nodeFor (<t>)))
    end
  |] }.
  Graph ::= '(' mkGraph = Exp ', ' mkNode = Exp ', ' mkEdge = Exp ')'

```

```

    GraphBody^ (mkGraph, mkNode, mkEdge) .
    GraphBody (mkGraph, mkNode, mkEdge) ::= ns = Nodes 'end' { [|
      <ns> (<mkGraph> (), <mkNode>, <mkEdge>, @Operation (g, E) g end)
    |] }.
    Label ::= NameExp | { "" . lift () }.
    NameExp ::= n = Name { n . lift () }.
    Nodes ::= n = Node ns = Nodes
      { [| addNodes (<n>, <ns>) |] }
    | { [| noNodes |] }.
    Node ::= l = Label d = Data e = Edges^ (l) { [|
      @Operation (Cn)
      @Operation (g, N, E, Ce)
      g . addToNodes (N (<l>, <d>));
      Cn (g, N, E, addEdges (<e>, Ce))
    end
    end
    |] }.
    OptData ::= Data | { [| Seq{} |] }.
end

```

BIBLIOGRAPHY

- [Boa01] OMG Architecture Board. Model Driven Architecture - a technical perspective. OMG document ormsc/01-07-01. On MDA website [mda], 2001.
- [Boo94] Grady Booch. *Object-Oriented Analysis and Design with Applications*. Addison-Wesley, 2nd edition, 1994.
- [CEF+99] Tony Clark, Andy Evans, Robert France, Stuart Kent, and Bernhard Rumpe. Response to UML 2.0 Request for Information. On pUML website [Gro], 1999.
- [CKM+99] Steve Cook, Anneke Kleppe, Richard Mitchell, Bernhard Rumpe, Jos Warmer, and Alan Wills. Defining UML family members using prefaces. In Christine Mingins, editor, *Proceedings of TOOLS Pacific 1999*. IEEE Computer Society, 1999.
- [Coi87] Pierre Cointe. Metaclasses are first class: the ObjVlisp model. In Norman Meyrowitz, editor, *Proceedings of the Conference on Object-Oriented Programming Systems, Languages and Applications*, pages 156–165. ACM, October 1987.
- [cwm04] Common Warehouse Metamodel. Available from <http://www.omg.org/cwm>, 2004.
- [DW99] Desmond F. D'Souza and Alan Cameron Wills. *Objects, Components, and Frameworks with UML: the Catalysis Approach*. Addison-Wesley, 1999.
- [emf08] Eclipse modeling framework. Available from <http://www.eclipse.org/modeling/emf>, 2008.
- [EMP08] Eclipse modeling project. <http://www.eclipse.org/modeling/>, 2008.

- [GAC⁺04] N. Georgalas, M. Azmoodeh, A. Clark, A. Evans, P. Sammut, and J. Willans. Mda-driven development of standard-compliant oss components: the oss/j inventory case-study. In *2nd European Workshop on MDA, Kent, UK*, 2004.
- [Gau04] P Gauthier. Oss inventory api - overview (part 1). Public Draft version 0.9, OSS through Java Initiative, 2004.
- [gmf08] Graphical modeling framework. Available from <http://www.eclipse.org/modeling/gmf>, 2008.
- [Gro] The Precise UML Group. The pUML website. <http://www.cs.york.ac.uk/puml/>.
- [Hof79] D. R. Hofstadter. *Goedel, Escher, Bach: An eternal golden braid*. Vintage Books, New York, 1979.
- [Jac92] Ivar Jacobson. *Object-Oriented Software Engineering*. Addison-Wesley, 1992.
- [Kob99] Cris Kobryn. UML 2001: a standardization odyssey. *Communications of the ACM*, 42(10), 1999.
- [Lar02] C. Larman. *Applying UML and Patterns: An Introduction to Object-Oriented Analysis and Design and the Unified Process*. Prentice Hall, 2002.
- [Lis08] Ansi common lisp. <http://clisp.cons.org/>, 2008.
- [mda] The OMG Model Driven Architecture website. <http://www.omg.org/mda/>.
- [mda01] Model Driven Architecture : The architecture of choice for a changing world. executive overview. On MDA website [mda], 2001.
- [Mel02] Stephen J. Mellor. Make models be assets. *Communications of the ACM*, 45(11), 2002.
- [MHP08] Mhp organization web site. <http://www.mhp.org>, 2008.
- [mof00] Meta Object Facility 1.3 specification. OMG document formal/00-04-03. On OMG website [omg], 2000.
- [ocl04] Ocl 2.0 revised submission. Available from <http://www.omg.org/cgi-bin/doc?ad/2003-01-07>, 2004.
- [omg] The Object Management Group website. <http://www.omg.org/>.
- [oss04] Oss through java initiative. Available from <http://www.ossj.org>, 2004.
- [qvt02] Request for proposal: MOF 2.0 Query / Views / Transformations RFP. OMG document ad/2002-04-10. On OMG website [omg], 2002.

- [RBP⁺91] James Rumbaugh, Michael Blaha, William Premerlani, Frederick Eddy, and William Lorenzen. *Object-Oriented Modeling and Design*. Prentice-Hall, 1991.
- [Sch08] Ansi common lisp. R5RS Revised Report on the Algorithmic Language Scheme available at <http://www.schemers.org/Documents/Standards/R5RS/>, 2008.
- [SM88] Sally Shlaer and Stephen J. Mellor. *Object Lifecycles: Modeling the World in States*. Yourdon Press, 1988.
- [Som95] Ian Sommerville. *Software Engineering*. Addison-Wesley, 5th edition, 1995.
- [SWU08] Stratego/swul. <http://www.program-transformation.org/Stratego/JavaSwulExamples>, 2008.
- [uml01] Unified Modeling Language 1.4 language specification. OMG document formal/2001-09-67. On OMG website [omg], 2001.
- [uml02] UML for Systems Engineering Request For Information. OMG document ad/2002-01-17. On OMG website [omg], 2002.
- [WK99] Jos B. Warmer and Anneke G. Kleppe. *Object Constraint Language: Precise Modeling with UML*. Addison-Wesley, first edition, 1999.
- [XMF08] Ceteva web site. <http://www.ceteva.com>, 2008.